



I/Q OUTPUT REFERENCE GUIDE

COMMUNICATIONS RECEIVER
IC-R8600

Table of contents

I/Q SIGNAL	2
■ General	2
◇ General description	2
■ Communication through the [I/Q OUT] port	3
◇ General description	3
◇ About the GUID	3
◇ About the endpoint	3
■ About the I/Q signals	4
◇ General description	4
■ I/Q data details	5
◇ 24-bit long I/Q data	5
◇ 16-bit long I/Q data	5
◇ Remarks	6
■ Control commands	7
◇ General description	7
◇ Command format	7
■ Usable control commands	9
◇ Command description	9
■ Control commands relative to I/Q port setting	10
◇ Receive frequency	10
◇ Receive Band edge frequency	10
◇ I/Q Output setting	11
■ Operations while the IC-R8600 is in the I/Q mode	13
◇ Operation limitations in the I/Q mode	13

I/Q SIGNAL

■ General

◇ General description

You can get I/Q signals from the [I/Q OUT] port on the IC-R8600 by connecting the IC-R8600 and a PC, with a USB cable. You can receive I/Q signals and control the IC-R8600, through the USB cable.

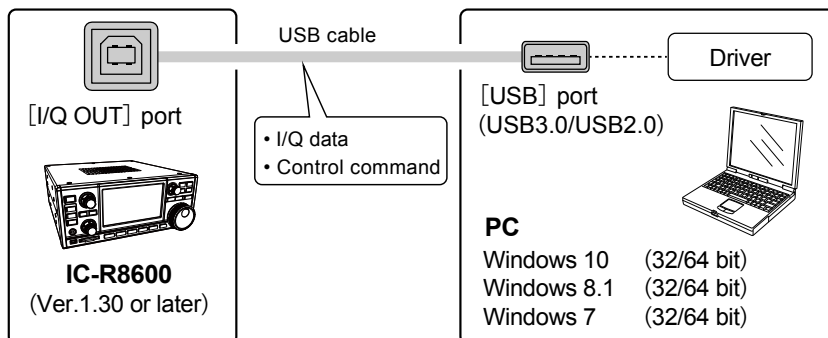

Requirement:

- IC-R8600 firmware must be version 1.3 or later.
- Windows 7 /8.1/10 PC (32 bit or 64 bit)
- USB 2.0 or higher
- USB I/Q driver (USB I/Q Package for HSDR)

You can download it from the Icom web site. (The software is commonly used with HSDR*.)

*An SDR receive software (freeware). You can download it from: <http://www.hdsdr.de/>

I/Q signal specifications:

Sampling frequency	Bit depth		Signal Bandwidth
	16-bit	24-bit	
5.12 MHz	Yes	N/A	4.48 MHz
3.84 MHz	Yes	Yes	3.31 MHz
1.92 MHz	Yes	Yes	1.63 MHz
960 kHz	Yes	Yes	815 kHz
480 kHz	Yes	Yes	408 kHz
240 kHz	Yes	Yes	203 kHz

■ Communication through the [I/Q OUT] port

◇ General description

I/Q signals and IC-R8600 control commands are exchanged through the [I/Q OUT] port on the IC-R8600.

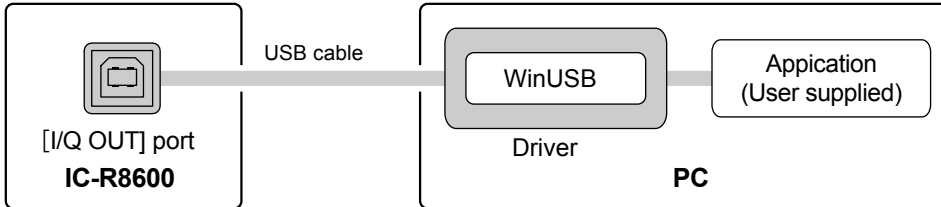

The communications are done through WinUSB. To use WinUSB, you need to install the driver (USB I/Q Package for HSDR) that can be downloaded from Icom web site.

After the driver is installed, you can receive I/Q signals and control the IC-R8600 through the WinUSB, using an I/Q receive software (user supplied).

To use WinUSB, you need to set the driver's GUID and appropriate "endpoint." Refer to the next topic for details about them.

◇ About the GUID

The GUID, that is needed to open the [I/Q OUT] port, is shown below.

68D5F5EE - B0E7 - 49FD - A0D5 - 5B10842656B7

◇ About the endpoint

The IC-R8600 has 3 endpoints. Each endpoint is reserved to receive I/Q data, to send control commands to the IC-R8600 and to receive the acknowledgement from the IC-R8600.

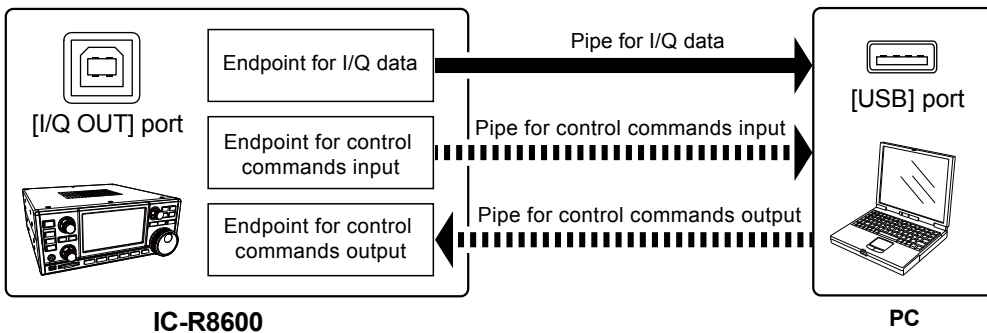

Details of each endpoint:

	Address (Hexadecimal)	Direction*	Endpoint Number (Hexadecimal)	Transfer Type
I/Q Data IC-R8600 → PC	86	IN	06	Bulk transfer
Control command IC-R8600 → PC	88	IN	08	Bulk transfer
Control Command PC → IC-R8600	02	OUT	02	Bulk transfer

*IN: Data from IC-R8600 to PC, OUT: Data from PC to IC-R8600

■ About the I/Q signals

◇ General description

I/Q data is output from the [I/Q OUT] port on the IC-R8600.

1 endpoint is reserved to receive I/Q signals.

	Address (Hexadecimal)	Direction	Endpoint Number (Hexadecimal)	Transfer Type
I/Q data IC-R8600 → PC	86	IN	06	Bulk transfer

The sampling frequency, Bit depth and I/Q signal bandwidth are as followed.

The sampling frequency and Bit depth can be set by the control command.

Sampling frequency	Bit depth		Signal bandwidth
	16-bit	24-bit	
5.12 MHz	Yes	N/A	4.48 MHz
3.84 MHz	Yes	Yes	3.31 MHz
1.92 MHz	Yes	Yes	1.63 MHz
960 kHz	Yes	Yes	815 kHz
480 kHz	Yes	Yes	408 kHz
240 kHz	Yes	Yes	203 kHz

① “I” and “Q” data are distinguished by the synchronous data that is periodically inserted into the packet. The contents of synchronous data is fixed, and the synchronous data is to be followed by a “I” signal.

① The data format (I/Q data and synchronous data) differs, depending on the bit depth (16-bit or 24-bit). (p. 5)

TIP:

The sampling frequency can be set to 120 kHz or less on the HDSDR application. This is achieved by a down sampling in the Dynamic Link Library (DLL).

I/Q SIGNAL

■ I/Q data details

◇ 24-bit long I/Q data

Data format:

The I/Q data is composed of 3 parts: "I" signals, "Q" signals and Synchronous signals.

Each data length is: "I" = 24 bits (3 Bytes), "Q" =24 bits (3 Bytes), Synchronous data=48 bits (6 Bytes).
(The byte order is in the little-endian format.)

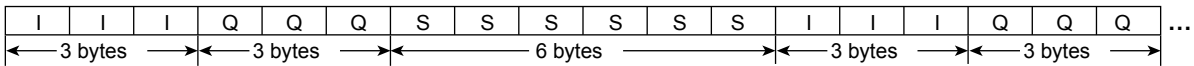

- The synchronous data is to be followed by an "I" signal.
- I/Q data range is "-8387967 (0x800281) ~ +8387966 (0x7FFD7E)."

The Synchronous data:

- Data length is 48 bits (6 bytes).
- The Synchronous data is composed of 6 bytes in total: 0x8000 (2 bytes), 0x8001 (2 bytes) and 0x8002 (2 bytes).

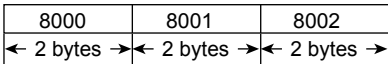

- The Synchronous data is inserted into the I/Q data, at the following rate.

Sampling rate	Synchronous data appearance rate
3.84 MHz	One Synchronous data in 8192 pairs of I and Q signals
1.92 MHz	One Synchronous data in 4096 pairs of I and Q signals
960 kHz	One Synchronous data in 2048 pairs of I and Q signals
480 kHz	One Synchronous data in 1024 pairs of I and Q signals
240 kHz	One Synchronous data in 512 pairs of I and Q signals

◇ 16-bit long I/Q data

Data format:

The I/Q data is also composed of 3 parts: "I" signals, "Q" signals and Synchronous signals.

Each data length is: "I" = 16 bits (2 Bytes), "Q" =16 bits (2 Bytes), Synchronous data=32 bits (4 Bytes).
(The byte order is in the little-endian format.)

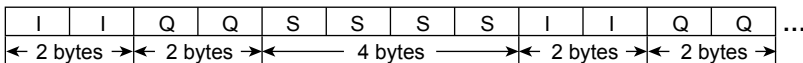

- The synchronous data is to be followed by an "I" signal.
- I/Q data range is "-32767 (0x8001) ~ +32767 (0x7FFF)."

The Synchronous data:

- Data length is 32 bits (4 bytes).
- The Synchronous data is composed of 4 bytes in total: 0x8000 (2 bytes) and 0x8000 (2 bytes).

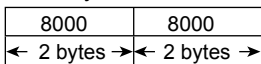

- The Synchronous data is inserted into the I/Q data, at the following rate.

Sampling rate	Synchronous data appearance rate
5.12 MHz	One Synchronous data in 10923 pairs of I and Q signals
3.84 MHz	One Synchronous data in 8192 pairs of I and Q signals
1.92 MHz	One Synchronous data in 4096 pairs of I and Q signals
960 kHz	One Synchronous data in 2048 pairs of I and Q signals
480 kHz	One Synchronous data in 1024 pairs of I and Q signals
240 kHz	One Synchronous data in 512 pairs of I and Q signals

I/Q SIGNAL

■ I/Q data details (Continued)

◇ Remarks

The I/Q data contains a DC component that is produced in the signal processing. The DC component appears as a constant frequency component positioned at the center frequency (0 Hz). A lower sampling frequency makes the DC component level greater.

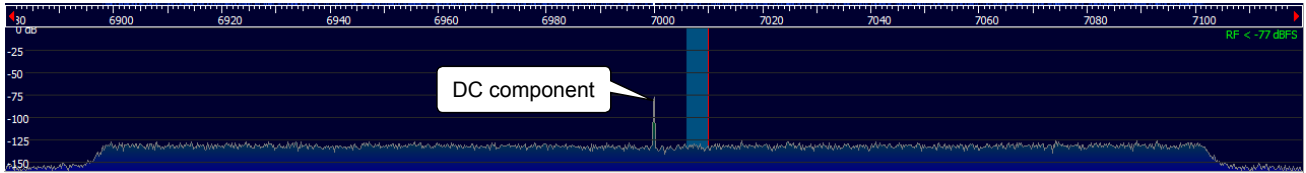

An example of the DC component that is monitored on the HDSDR software. (Display frequency= 7 MHz, Sampling frequency=240 kHz)

Control commands

General description

Following 2 endpoints are reserved to send control commands:

- Sends the control commands from a PC to the IC-R8600.
- Sends the acknowledgement from the IC-R8600 to the PC.

	Address (Hexadecimal)	Direction	Endpoint Number (Hexadecimal)	Transfer Type
Control command IC-R8600 → PC	88	IN	08	Bulk transfer
Control command PC → IC-R8600	02	OUT	02	Bulk transfer

① The control command format is based on the ICOM Communication Interface V (CI-V) format.

① There are 2 command types: Writing commands and Reading commands. Refer to the next topic for details about them.

Command format

You can control the IC-R8600 using the CI-V commands. Every command is composed of a byte array in hexadecimal. Every command's total length in bytes must be an even number.

After sending a command from the PC to IC-R8600, an acknowledgement is returned. When you send commands one after another, you need to send the next command after the acknowledgement is received.

Writing command format:

Send a writing command from PC to change an IC-R8600 setting.

A writing command is composed of a command number and setting data that follows the command.

The IC-R8600 will return the result as an acknowledgement after receiving a command.

• Command (PC to IC-R8600)

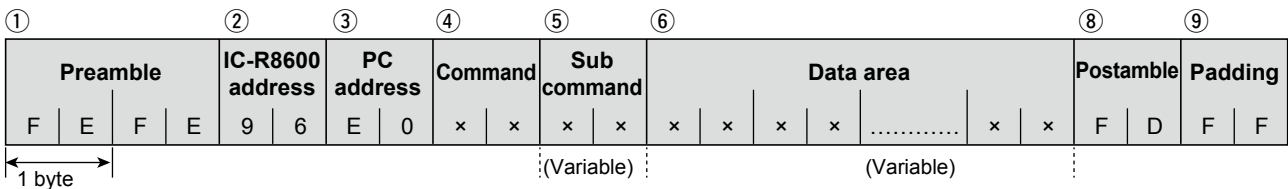

• Acknowledge to a valid command (IC-R8600 to PC)

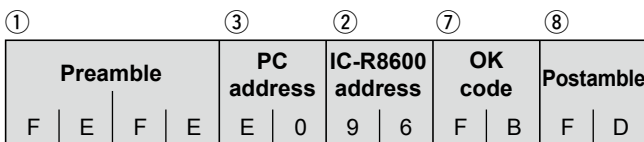

• Acknowledge to an invalid command (IC-R8600 to PC)

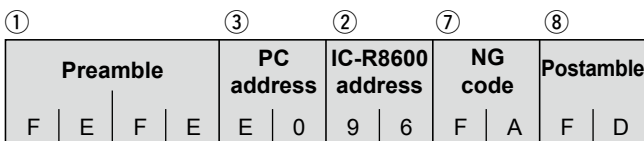

I/Q SIGNAL

Control commands

Command format (Continued)

Reading command format:

Send a request command from the PC to request to return an IC-R8600 setting value.

A reading command is composed of only a command number.

The IC-R8600 will return the requested setting value as an acknowledgement when receiving the command.

If the request command is invalid, "NG (FA)" will be returned as the acknowledgement.

Command (PC to IC-R8600)

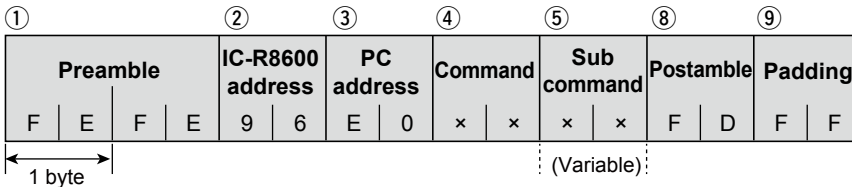

Acknowledgement to a valid command (IC-R8600 to PC)

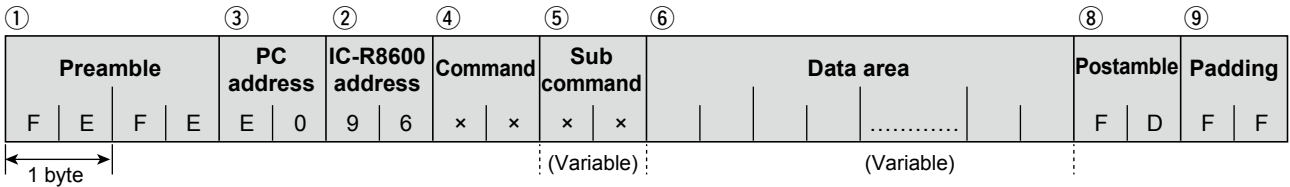

Acknowledgement to an invalid command (IC-R8600 to PC)

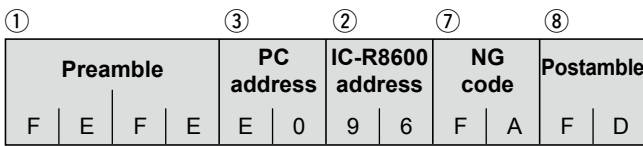

PC to IC-R8600

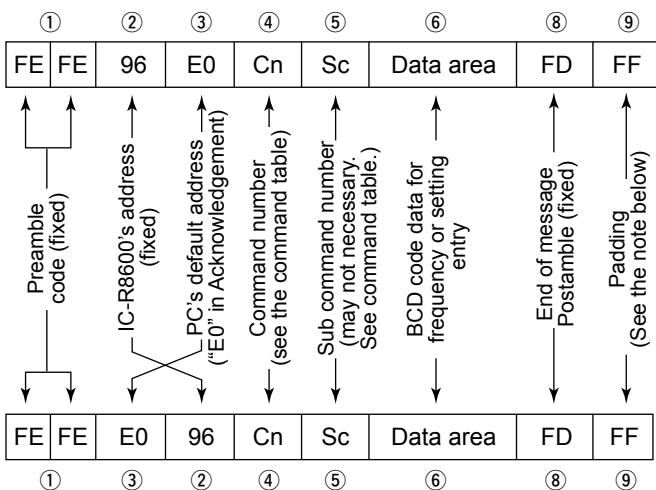

IC-R8600 to PC

OK message to PC

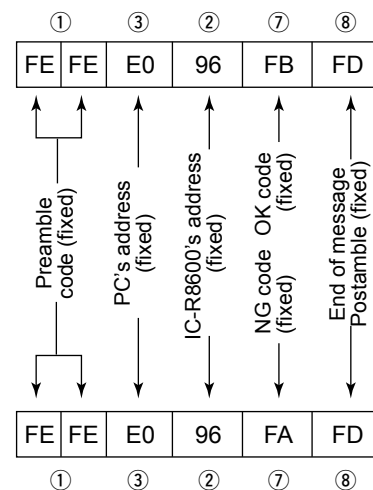

NG message to PC

NOTE: When the data length is an odd number

Every command's total length in byte must be an even number.

If the total length is an odd number, you need to add an extra "FF" at the end of the packet, to make the length an even number. In the same manner, the length of the acknowledgement data from the IC-R8600 is an even number.

■ Usable control commands

◇ Command description

Some commands can both read and write data, while others can only read or write.

Usable commands differ, according to the I/Q mode state (ON or OFF).

Command Number	Sub command Number	Data	Command Function	When the I/Q mode is OFF	When the I/Q mode is ON	
05		See p.10	Set the receive frequency.	Not usable	Usable	
11*		00, 10, 20, 30	Send/read the Attenuator (00=ATT OFF, 10=10 dB, 20=20 dB, 30=30 dB)	Not usable	Usable	
12*		00~02	Send/read the antenna connector (only in the HF band) (00=ANT1, 01=ANT2, 02=ANT 3)	Not usable	Usable	
14*	02	0000~0255	Send/read the RF Gain (0000=Minimum, 0255=Maximum) (BCD value)	Not usable	Usable	
16*	02	00/01	Send/read the PRE-AMP setting (00=OFF, 01=ON)	Not usable	Usable	
	65	00/01	Send/read the IP+ function status (00=OFF, 01=ON)	Not usable	Usable	
1A	0E		Read the band edge Count (Number of data in an edge unit returned in a BCD value.)	Not usable	Usable	
	0F	See p.10	Read the band edge frequency	Not usable	Usable	
	12	00/01	The OVF Indicator status (00=OFF, 01=ON)	Not usable	Usable	
	13*	00	00/01	Send/read the I/Q mode status (00=OFF, 01=ON)	Usable	Usable
		01	See p.11	Send/read I/Q Output setting	Set to "ON": Not usable	Usable
			Set to "OFF": Usable			
			Read setting: Usable			
	02	00/01	Send/read HF band BPF setting (00=OFF, 01=ON)	Not usable	Usable	
Commands other than listed above				Not usable	Not usable	

*(Asterisk) Send/read data

Control commands relative to I/Q port setting

Receive frequency

Command: 05

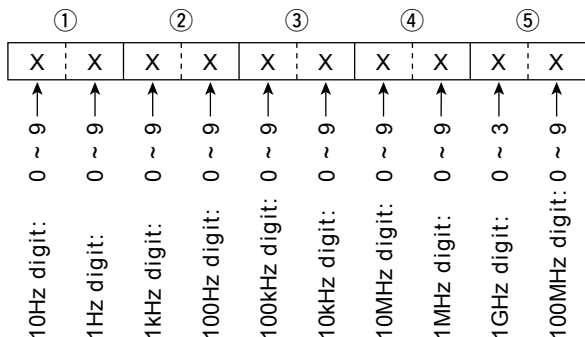

① You can omit the upper digits entry. When omitted, the current frequency is applied.

Receive Band edge frequency

Command: 1A 0F

PC to IC-R8600 (Write data format)

Specify the band edge to read by the edge number in a BCD code.



↑ Edge number: 01 to XX*

① The upper number (*marked) will be the returned value of command "1A 0E."

① If the specified number exceeds the readable capacity, "NG (FA)" will be returned.

To read the number of the edge, send command "1A 0E" (The Read Receive Band Edge Count command).

IC-R8600 to PC (Read data format)

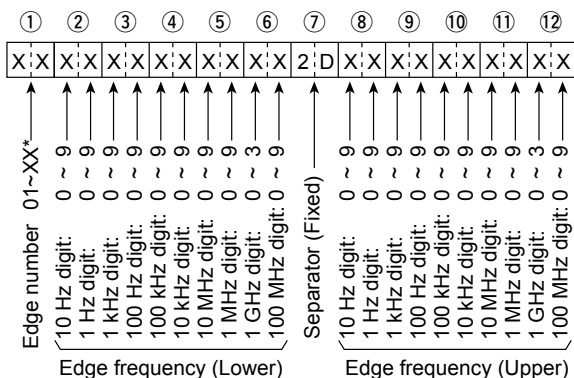

① The upper number (*marked) will be the returned value of command "1A 0E."

① The lower edge frequency, separator (fixed to "2D") and upper edge frequency are returned as well as the Edge number.

I/Q SIGNAL

■ Control commands relative to I/Q port setting (Continued)

◇ I/Q Output setting

Command: **1A 13 01**

PC to IC-R8600 (Write data format):

Sets the I/Q output setting to ON or OFF.

• Turning OFF the I/Q signal output

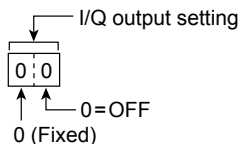

• Turning ON the I/Q signal output

Also sends the bit depth and sampling frequency data.

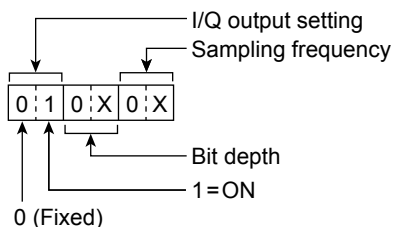

You can set the I/Q signal output setting by sending the command through the [I/Q OUT] port.

Only when the I/Q mode is set to “ON,” you can set the I/Q output to ON.

When the sent command is valid and accepted by the IC-R8600, the acknowledgement “OK (FB)” will be returned. “NG (FA)” will be returned if invalid.

I/Q Output	Bit depth	Sampling frequency	
00: OFF	00: 16-bit	01 5.12 MHz	04 960 kHz
01: ON	01: 24-bit	02 3.84 MHz	05 480 kHz
–	–	03 1.92 MHz	06 240 kHz

NOTE: The combination of 5.12 MHz and 24 bit is invalid, and “NG (FA)” will be returned.

I/Q SIGNAL

■ Control commands relative to I/Q port setting

◇ I/Q Output setting (Continued)

IC-R8600 to PC (Read data format):

Reads the I/Q output settings.

• When the I/Q signal output is OFF

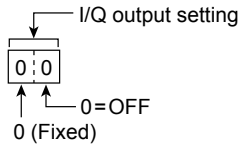

• When the I/Q signal output is ON

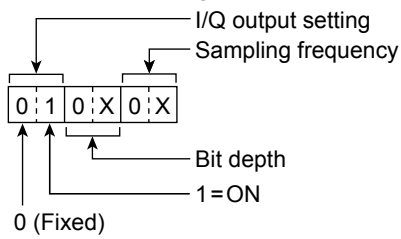

① Also the bit depth and sampling frequency are returned.

I/Q Output	Bit depth	Sampling frequency	
00: OFF	00: 16 bit	01 5.12 MHz	04 960 kHz
01: ON	01: 24 bit	02 3.84 MHz	05 480 kHz
—	—	03 1.92 MHz	06 240 kHz

■ Operations while the IC-R8600 is in the I/Q mode

You need to enter the I/Q mode to get I/Q signals.

While the IC-R8600 is in the I/Q mode, [REMOTE] LED lights and the IC-R8600 is in the “Remote controlled mode,” thus you cannot operate the IC-R8600.

To exit the I/Q mode, send the command that cancels the mode, or push the [LOCAL] key on the IC-R8600 front panel. Turning OFF the IC-R8600’s power also exits the I/Q mode.

While the IC-R8600 is in the I/Q mode, the operations that a user can perform are limited.

◇ Operation limitations in the I/Q mode

Setting:

All changes (frequency, preamp setting, and so on) made in the I/Q mode are not saved.

All the settings will be returned to the condition/state before entering the I/Q mode.

Receive setting:

While in the I/Q mode, the receive mode is fixed to “USB,” and “AGC” is forcibly turned OFF.

Audio output:

Audio output from the internal speaker, external speaker terminal and headphone terminal are muted.

The audio output from the USB Audio, [AF/IF] terminal and [LAN] port are not muted.

The Monitor function is forcibly turned OFF.

Others:

- Normal scan, Priority scan and Tone scan are not usable. (Forcibly canceled if running.)
- The Recording function is not usable.
- The Memory channel is not automatically changed by the Timer function.
(The Automatic Power OFF function is still usable.)
- The BER measurement function is not usable, and forcibly turned OFF if in use.
- “NG (FA)” will be returned to all the commands excepts those related to the I/Q mode: reading and entering the I/Q mode. Setting receive frequency, receive mode transceive and receiving digital signals are disabled.
- The cloning operation using the CS-R8600 is not usable.
- The IF signal from the 10.7 MHz OUT is disabled.

Count on us!

