



I/Q OUTPUT REFERENCE GUIDE

HF/50MHz TRANSCEIVER

IC-7610

Table of contents

I/Q SIGNAL	3
■ General	3
◇ General description	3
■ Communication through the [USB 2] port	4
◇ General description	4
◇ About the Device Description	4
◇ About the endpoints	4
■ About the I/Q signals	5
◇ General description	5
◇ I/Q data format	5
■ Control commands	6
◇ General description	6
◇ Command format	6
■ Usable control commands	8
◇ Command description	8
■ Control commands relative to the I/Q port settings	9
◇ Antenna	9
◇ Operating frequency	9
◇ Operating mode	10
◇ Setting after directly specifying the Main/Sub band	11

I/Q SIGNAL

■ General

◇ General description

You can get I/Q signals from the [USB 2] port on the IC-7610 by connecting the IC-7610 and a PC, with a USB cable. You can receive I/Q signals and control the IC-7610, through the USB cable.

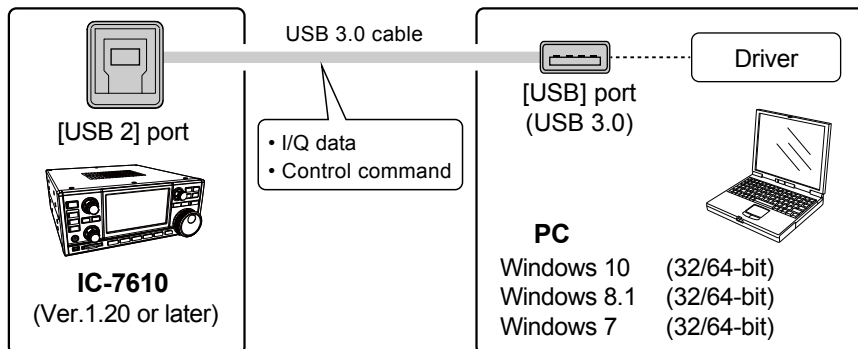

Requirement:

- IC-7610 firmware must be version 1.20 or later.
- Windows 7 /8.1/10 PC (32 bit or 64 bit)
- USB 3.0 or higher
- USB I/Q driver (USB I/Q Package for HDSDR)
 You can download it from the Icom web site. (The software is commonly used with HDSDR*.)
 *An SDR receive software (freeware). You can download it from: <http://www.hdsdr.de/>

I/Q signal specifications:

Sampling frequency	Bit depth	Signal Bandwidth	Band (Main/Sub)
1.92 MHz	16-bit	1.66 MHz	Main or Sub (Selectable)

■ Communication through the [USB 2] port

◇ General description

I/Q signals and IC-7610 control commands are exchanged through the [USB 2] port on the IC-7610.

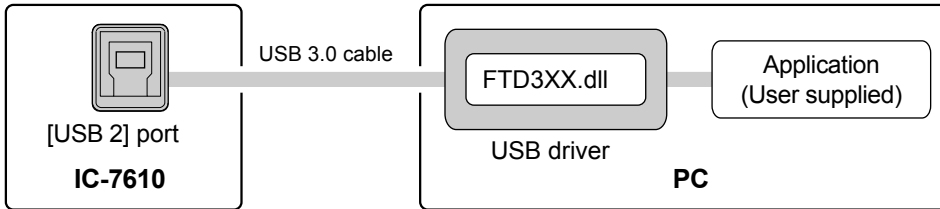

The communications are done through FTDI's "D3XX Driver."

You need to install the driver (USB I/Q Package for HDSDR) that can be downloaded from Icom web site. After the driver is installed, you can receive I/Q signals and control the IC-7610 through the D3XX Driver, using an I/Q receive software (user supplied).

To receive I/Q signals and control the IC-7610 from the user application, you need FTDI's "FTD3XX.dll." Refer to "D3XX Programmer's Guide" that can be downloaded from FTDI web site on how to use the functions.

You need to set the device description and appropriate "endpoint." Refer to the next topic for details about them.

◇ About the Device Description

The Device Description, that is needed to open the [USB 2] port, is shown below.

"IC-7610 SuperSpeed-FIFO Bridge"

◇ About the endpoints

The IC-7610 has 3 endpoints. Each endpoint is reserved to receive I/Q data, to send control commands to the IC-7610 and to receive the acknowledgement from the IC-7610.

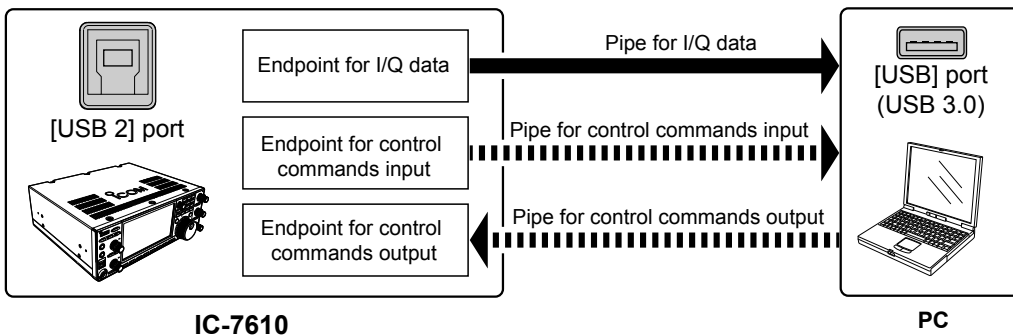

Details of each endpoint:

	Address (Hexadecimal)	Direction*	Endpoint Number (Hexadecimal)	Transfer Type
I/Q Data IC-7610 → PC	84	IN	04	Bulk transfer
Control command IC-7610 → PC	82	IN	02	Bulk transfer
Control Command PC → IC-7610	02	OUT	02	Bulk transfer

*IN: Data from IC-7610 to PC, OUT: Data from PC to IC-7610

■ About the I/Q signals

◇ General description

I/Q data is output from the [USB 2] port on the IC-7610.

One endpoint is reserved to receive I/Q signals.

	Address (Hexadecimal)	Direction	Endpoint Number (Hexadecimal)	Transfer Type
I/Q data IC-7610 → PC	84	IN	04	Bulk transfer

The sampling frequency, Bit depth and I/Q signal bandwidth are fixed as follows.

Sampling frequency	Bit depth	Signal Bandwidth	Band (Main/Sub)
1.92 MHz	16-bit	1.66 MHz	Main or Sub (Selectable)

TIP:

The sampling frequency can be set to 960 kHz or less in the HSDR application.

You can select the Bit depth in the HSDR application.

These are achieved by processing down sampling and bit conversion on the PC.

◇ I/Q data format

Data format:

The I/Q data is composed of 2 parts: "I" signals and "Q" signals.

Each data length is: "I" =16 bits (2 Bytes), "Q" =16 bits (2 Bytes).

(The byte order is in the little-endian format.)

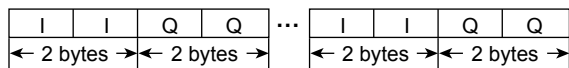

- I/Q data range is "-32768 (0x8000) ~ +32767 (0x7FFF)."
- I/Q data is formed in increments of 4 bytes. Therefore the most significant byte must be an I signal.

■ Control commands

◇ General description

The following 2 endpoints are reserved for sending control commands:

- Sends the control commands from a PC to the IC-7610.
- Sends the acknowledgement from the IC-7610 to the PC.

	Address (Hexadecimal)	Direction	Endpoint Number (Hexadecimal)	Transfer Type
Control command IC-7610 → PC	82	IN	02	Bulk transfer
Control command PC → IC-7610	02	OUT	02	Bulk transfer

① The control command format is based on the ICOM Communication Interface V (CI-V) format.

① There are 2 command types: Writing commands and Reading commands. Refer to the next topic for details about them.

◇ Command format

You can control the IC-7610 using the CI-V commands. Every command is composed of a byte array in hexadecimal. Every command byte must be in increments of 4 bytes.

After sending a command from the PC to the IC-7610, an acknowledgement is returned. When you send commands one after another, you need to send the next command after the acknowledgement is received.

Writing command format:

Send a writing command from the PC to change an IC-7610 setting.

A writing command is composed of a command number and setting data that follows the command.

The IC-7610 will return the result as an acknowledgement after receiving the command.

• Command (PC to IC-7610)

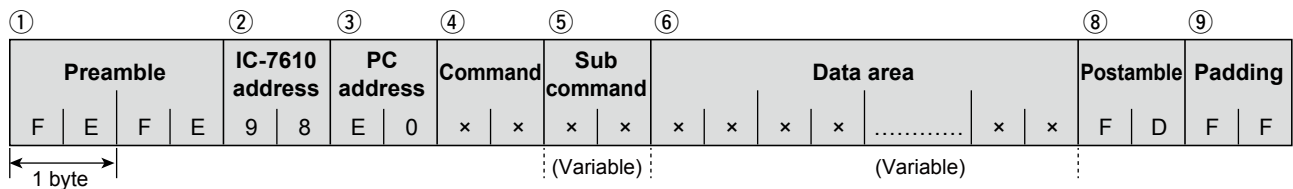

• Acknowledge of a valid command (IC-7610 to PC)

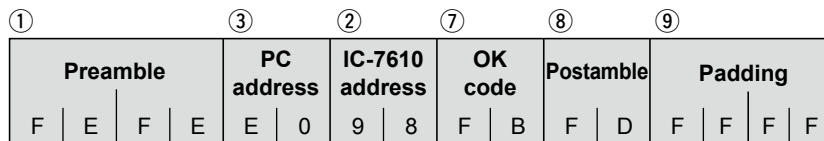

• Acknowledge of an invalid command (IC-7610 to PC)

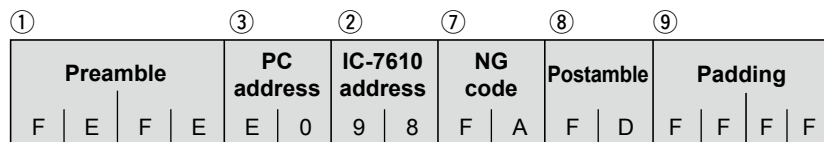

I/Q SIGNAL

Control commands

Command format (Continued)

Reading command format:

Send a request command from the PC to request to return an IC-7610 setting value.

A reading command is composed of only a command number.

The IC-7610 will return the requested setting value as an acknowledgement when receiving the command.

If the request command is invalid, "NG (FA)" will be returned as the acknowledgement.

Command (PC to IC-7610)

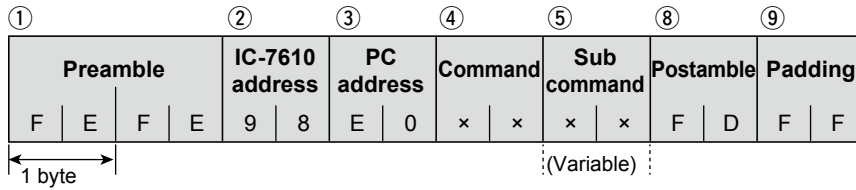

Acknowledgement of a valid command (IC-7610 to PC)

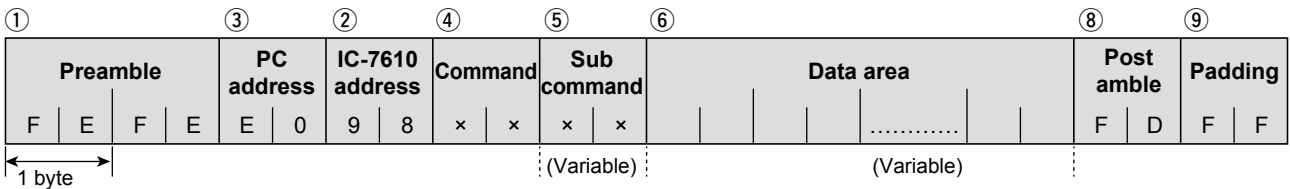

Acknowledgement of an invalid command (IC-7610 to PC)

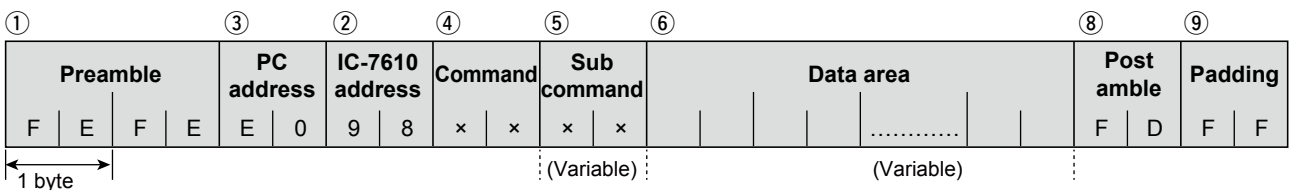

PC to IC-7610

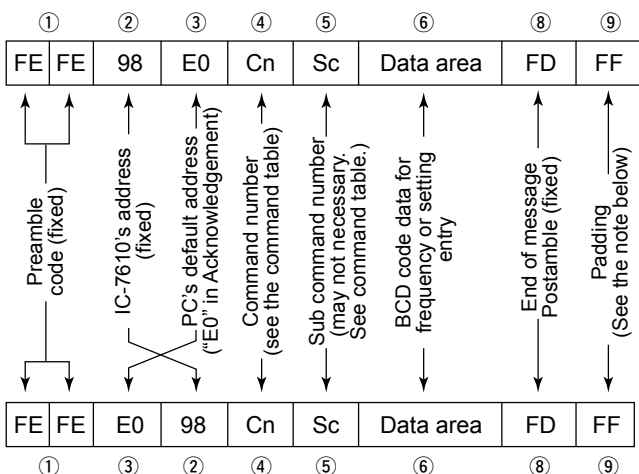

IC-7610 to PC

OK message to PC

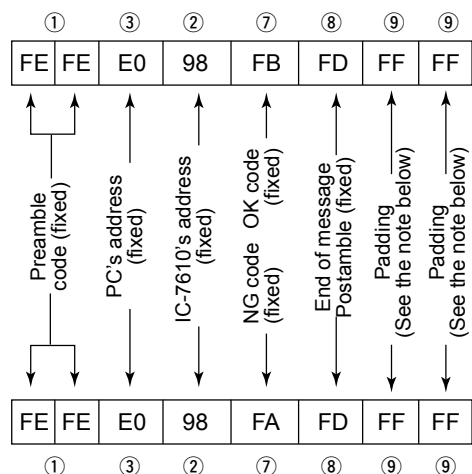

NG message to PC

NOTE: When the data length is not in increments of 4 bytes

Every command must be in increments of 4 bytes.

If the command is not in increments of 4 bytes, you need to add an extra "FF" at the end of the packet, to make the command length a multiples of 4. In the same manner, the length of the acknowledgement data from the IC-7610 is a multiples of 4.

■ Usable control commands

◇ Command description

Command Number	Sub command Number	Data	Command Function
07	C2	00/01	Send/read the dualwatch setting (00=OFF, 01=ON)
	D2	00/01	Send/read the band selection (00=Main, 01=Sub)
0F		00/01	Send/read the split setting (00=Split OFF, 01=Split ON)
11 ⑳		00, 03 ~ 45	Send/read the Attenuator (00=ATT OFF, 03=Minimum ~ 45=Maximum (3 dB step))
12 ⑳		See p.9	Send/read the antenna
14	02 ⑳	0000 ~ 0255	Send/read the RF Gain (0000=Minimum, 0255=Maximum) (BCD value)
16*	02 ⑳	00/01/02	Send/read the PRE-AMP setting (00=OFF, 01=P.AMP1 ON, 02=P.AMP2 ON)
	4E ⑳	00/01	Set the DIGI-SEL function (00=OFF, 01=ON)
	65 ⑳	00/01	Send/read the IP+ function status (00=OFF, 01=ON)
1A	0A* ⑳	00/01	Read the OVF indicator status (00=OFF, 01=ON)
	0B	00/01/02	Send/read the I/Q data output setting (00=OFF, 01=Main band I/Q output, 02=Sub band I/Q output)
1C	00	00/01	Transceiver's status (00=RX, 01=TX)
	02	00/01	Transmit frequency monitor (XFC) (00=OFF, 01=ON)
25		See p.9	Send/read the Main or Sub band frequency
26		See p.10	Set the operating mode and filter setting
29		00 or 01 + Supported commands See p.11	Regardless of active/inactive of the Main or Sub band, you can directly specify the Main or Sub band, and send/read the supported command settings. (00=Main band, 01=Sub band)
Commands other than listed above cannot be used with the [USB 2] port.			

*(Asterisk) Read only data

⑳ Regardless of active/inactive the Main or Sub band, you can directly specify the Main or Sub band, and send/read the supported command settings. See page 11 for details.

■ Control commands relative to the I/Q port settings

◇ Antenna

Command: 12

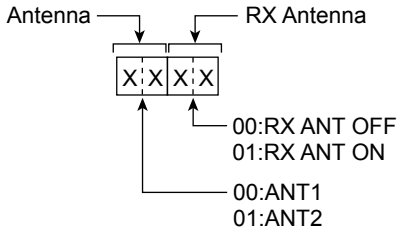

① If the RX-ANT Connectors item is set to “Connect External RX Device,” “OFF” will be returned. If “ON” is sent, “NG” (FA: in Hexadecimal) will be returned.

◇ Operating frequency

Command: 25

•Reading

Command (PC to IC-7610)

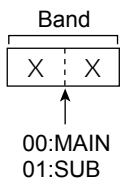

Acknowledgement of a valid command (IC-7610 to PC)

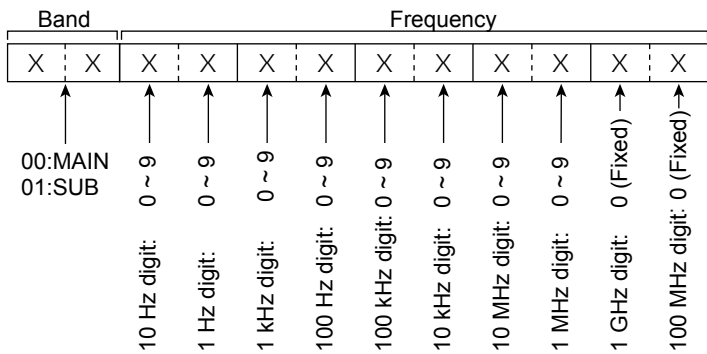

•Setting

Command (PC to IC-7610)

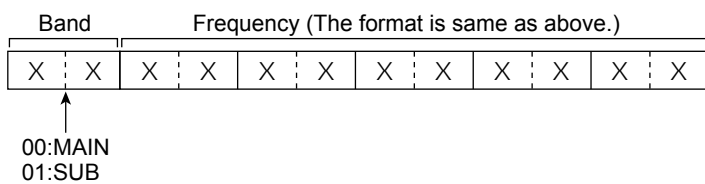

① Fill each digit with the BCD value.

② If you omit entry of the digit upper than entered position, the current frequency will be applied to the upper digits.

■ Control commands relative to the I/Q port settings (Continued)

◇ Operating mode

Command: 26

•Reading

Command (PC to IC-7610)

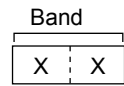

00:MAIN
01:SUB

Acknowledgement of a valid command (IC-7610 to PC)

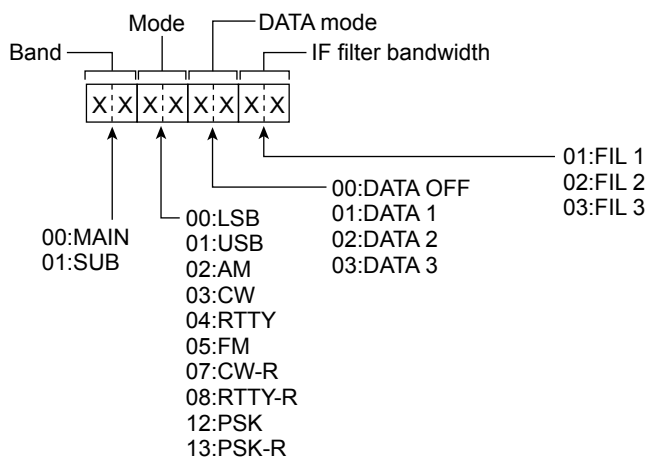

•Setting

Command (PC to IC-7610)

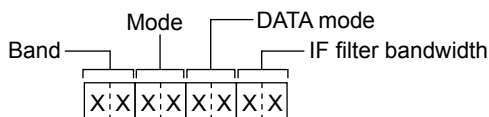

① The data format is the same with that of “Reading.”

① You can omit the IF filter width and DATA. When omitted, the current setting is applied.

Control commands relative to the I/Q port settings (Continued)

Setting after directly specifying the Main/Sub band

Command: 29

Specify the Main or Sub band before entering the supported commands.

When you receive the OK code (FB), or the NG code (FA), Command 29 and the Main/Sub specified 00 or 01 is omitted.

•Reading

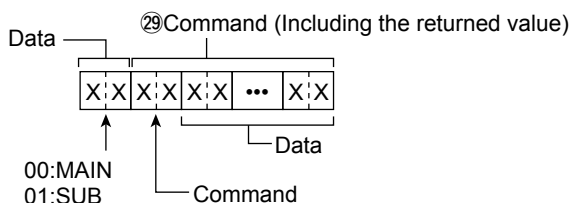

Example: Reading the Main band RF gain using the "14 02" command.

Command (PC to IC-7610)

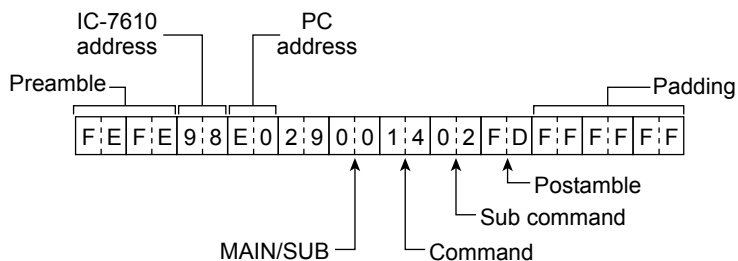

Acknowledgement of a valid command (IC-7610 to PC)

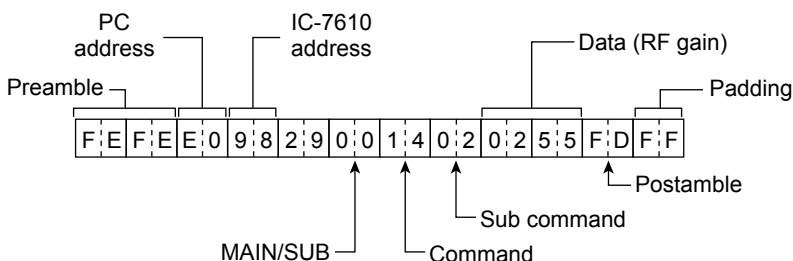

■ Control commands relative to the I/Q port settings

◇ Setting after directly specify the Main/Sub band (Continued)

Command: 29

Specify the Main or Sub band before entering the supported commands.

When you receive the OK code (FB), or the NG code (FA), Command 29 and the Main/Sub specified 00 or 01 is omitted.

•Setting

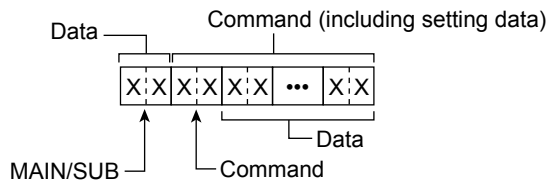

Example: Setting the SUB band RF gain to “128” using 14 02 command.

Command (PC to IC-7610)

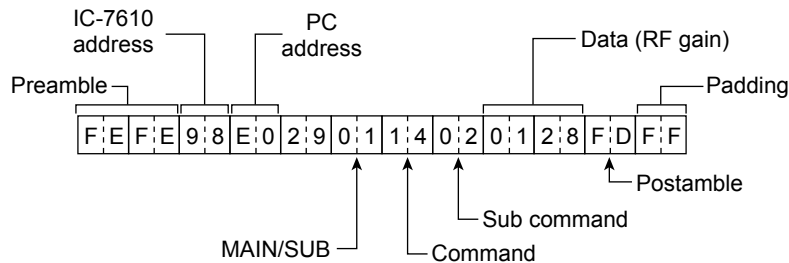

Acknowledgement of a valid command (IC-7610 to PC)

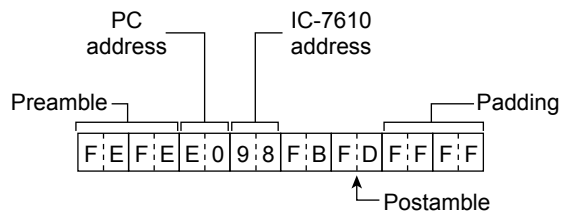

① You can omit the IF filter width and DATA. When omitted, the current setting is applied.

Count on us!

