

# Preparations for using the IC-7610 with the HSDR application

The IC-7610 (with firmware version 1.20 or later) can output the In-phase/Quadrature (I/Q) data that is processed by the FPGA. Connect [USB 2] to a PC's USB port, and you can control the IC-7610 from a PC using the HSDR application.

## Procedure outline

To use the IC-7610's [USB 2] port as an I/Q port for the first time, follow the steps described below.

- ① For the settings and operations of HSDR, see the document "IC-7610 HSDR Operating Guide," which can be downloaded from the Icom website.
- ① Before you start using the IC-7610 with HSDR, check the PC system requirements, as shown on page 2.

### Step 1. Confirming the IC-7610 firmware version (See Section 13 of the IC-7610 Advanced manual.)

Confirm the IC-7610 firmware version is 1.20 or later.

- ① If the IC-7610 firmware version is 1.11 or earlier, download the latest firmware version from the Icom website, and update your IC-7610 to be compatible with the I/Q output.  
<http://www.icom.co.jp/world/support/>
- ① See Section 13 of the IC-7610 Advanced manual for details on how to update.

### Step 2. Installing HSDR

**NOTE:** First install HSDR before installing "IC-7610 USB I/Q Package for HSDR."

You can use HSDR (freeware) as an SDR application.

Download HSDR (Version 2.76a) from the HSDR website and install it.

<http://www.hdsdr.de/>

- ① When using CW Skimmer, install the other required applications to suit your operating needs. (pp. 3 ~ 4)
- ① Icom does not offer technical support for your PC settings or any use of 3rd party applications.

### Step 3. Installing "IC-7610 USB I/Q Package for HSDR" (pp. 5 ~ 6 in this document)

**CAUTION: DO NOT** connect the IC-7610 and a PC until the driver installation has been completed.

To control the IC-7610 from a PC using HSDR, download "IC-7610 USB I/Q Package for HSDR" from the Icom website, and install it.

<http://www.icom.co.jp/world/support/>

The package contains "ExtIO\_IC7610.dll" and an IQ driver.

The DLL file is normally saved in the same folder where HSDR is installed as the default.

(Example: C:\Program Files\HSDR)

- ① Install the package onto your PC. See pages 5 ~ 6 for installation details.

### Step 4. Connecting the IC-7610 and a PC (p. 7 in this document)

Connect a USB 3.0 cable (User supplied) between the IC-7610's [USB 2] port and one of your PC's USB ports, and then turn ON the IC-7610.

- ① This document describes only hardware connections.

### Step 5. Using HSDR ("IC-7610 HSDR Operating Guide")

See "IC-7610 HSDR Operating Guide" to use the application with the IC-7610.

This document gives 4 examples to control the IC-7610 from a PC using the HSDR application. (pp. 3 ~ 4)

#### **TIP: Updating "IC-7610 USB I/Q Package for HSDR":**

If you already have the package installed, you can download the latest version and update it by doing an overwrite installation.

# System requirements

Use a PC that meets the system requirements as described below.

## Minimum system requirements

<b>Operating System</b>	Microsoft® Windows® 10 (32/64 bit) Microsoft® Windows® 8.1 (32/64 bit) ① Except for Microsoft® Windows® RT Microsoft® Windows® 7 (32/64 bit)  ① In this guide, the OSs are described as “Windows 10,” “Windows 8.1,” and “Windows 7.”
<b>USB ports</b>	USB 3.0
<b>USB cable</b>	USB 3.0
<b>Remarks</b>	We recommend that you use the on-board sound chipset. The CPU may have a heavy load when an external sound device, such as USB audio converter, is used.

These are the minimum system requirements to use the IC-7610 with the HDSDR application. Depending on your PC environment (permanently running software such as antivirus software, peripheral devices, settings of OS and other software), the operation of the IC-7610 with the HDSDR application may not perform properly.

## Operation notes

- Before connecting or disconnecting a USB cable, turn OFF the IC-7610.
- Depending on the PC performance, OS, condition, speed, and so on, the USB audio may be interrupted, or control by the PC software may be delayed.
- If the CPU has a heavy load, the USB audio is easily interrupted. If the audio is interrupted, set a lower sampling rate in the HDSDR application or close other applications, if running.
- To operate your PC and peripheral devices, follow the instructions provided in their manuals.
- This USB I/Q Package is designed only for the IC-7610. Icom does not guarantee its use with other transceivers.

Icom, Icom Inc. and Icom logo are registered trademarks of Icom Incorporated (Japan) in Japan, the United States, the United Kingdom, Germany, France, Spain, Russia, Australia, New Zealand, and/or other countries.

Microsoft and Windows are registered trademarks of Microsoft Corporation in the United States and/or other countries.

HDSDR is the property of Mr. Mario Täeubel (DG0JBJ).

CW skimmer is the property of Afreet Software, Inc.

Null-modern emulator (com0com) is an open source software based on the GPLv2 license.

VB-Audio Hi-Fi Cable is the property of Mr. Vincent Burel.

N1MM Logger+ is the property of Mr. Thomas F Wagner (N1MM).

All other products or brands are registered trademarks or trademarks of their respective holders.

# IC-7610 HSDR operations

This section gives 4 examples to control the IC-7610 from a PC using the HSDR application.

① The detailed software connections, settings, and operating instructions are described in the "IC-7610 HSDR Operating Guide."

## A. Using the IC-7610 with HSDR

The I/Q data output from the IC-7610's MAIN or SUB band is input to your PC. The input I/Q data can be received on HSDR.

① The HSDR's local oscillator frequency (LO) is synchronized with the IC-7610's operating frequency.

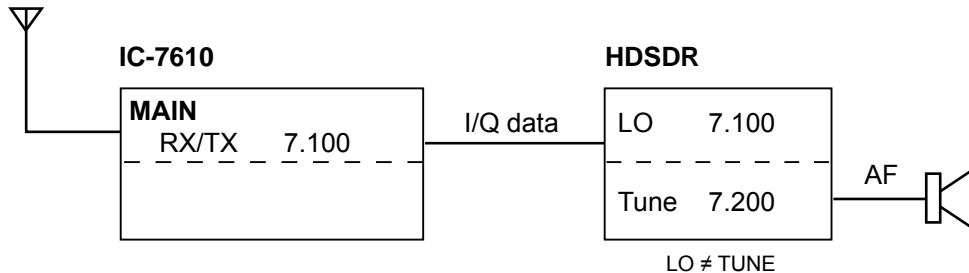

## B. Using HSDR as a 3rd receiver

The IC-7610 has the Dualwatch function. Furthermore, you can use the HSDR application as a 3rd receiver by inputting the I/Q data that is output from the IC-7610's MAIN or SUB band. You can receive 3 different frequencies at the same time.

① The HSDR's local oscillator frequency (LO) is synchronized with the IC-7610's operating frequency.

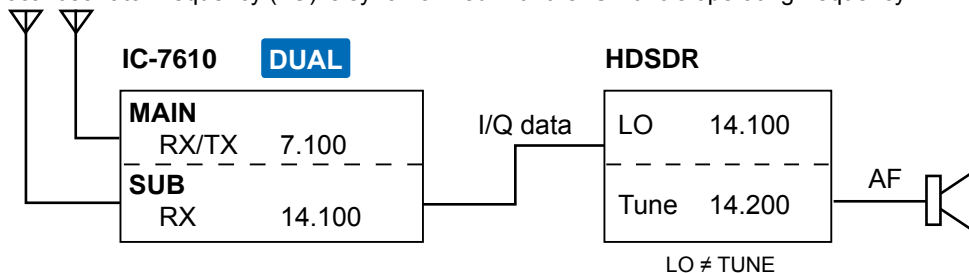

## C. Using HSDR with CW Skimmer (For a narrow 24 kHz bandwidth)

The CW Skimmer application decodes the CW signals received from HSDR.

Use this way when:

- Calling a station whose CW signals are displayed on CW Skimmer.
- Calling a station that is in the Split operation and in a pile up during a DXpedition.
- Checking the CW band on CW Skimmer while communicating in the SSB mode.

① The HSDR's local oscillator frequency (LO) and HSDR, CW Skimmer's operating frequencies are all synchronized with the IC-7610's operating frequency.

Install **CW Skimmer** (Shareware), **VB-Audio Hi-Fi Cable** (Donationware), and **Null-modem emulator (com0com)** (Freeware).

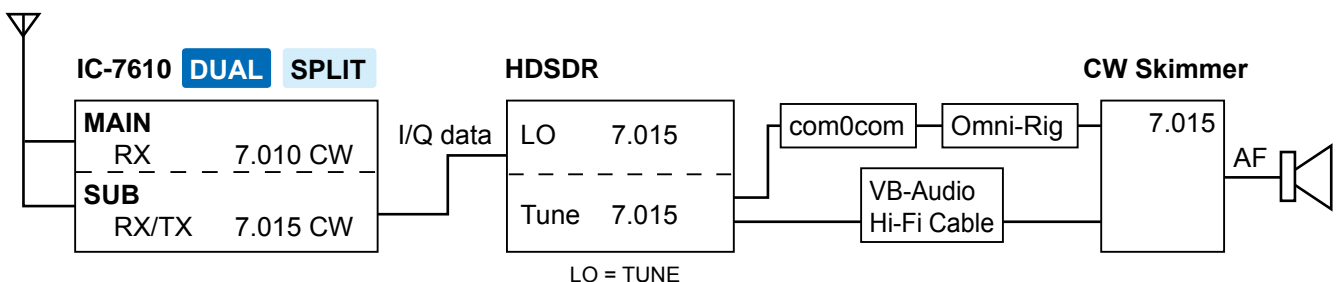

► Continued on the next page.

**D. Using HSDR with CW Skimmer (For a wide\* bandwidth)**

The CW Skimmer application decodes the CW signals received from HSDR.

\* Approximately 170 kHz

Use this way when checking the wide band and getting information of many CW stations. This way is useful when you participate in a CW contest.

- ① The HSDR's local oscillator frequency (LO) is synchronized with the IC-7610's operating frequency.
- ① Manually set the same frequency to the HSDR Tune frequency and the CW Skimmer LO frequency.

Install **CW Skimmer** (Shareware), **VB-Audio Hi-Fi Cable** (Donationware), and **N1MM Logger+** (Freeware).

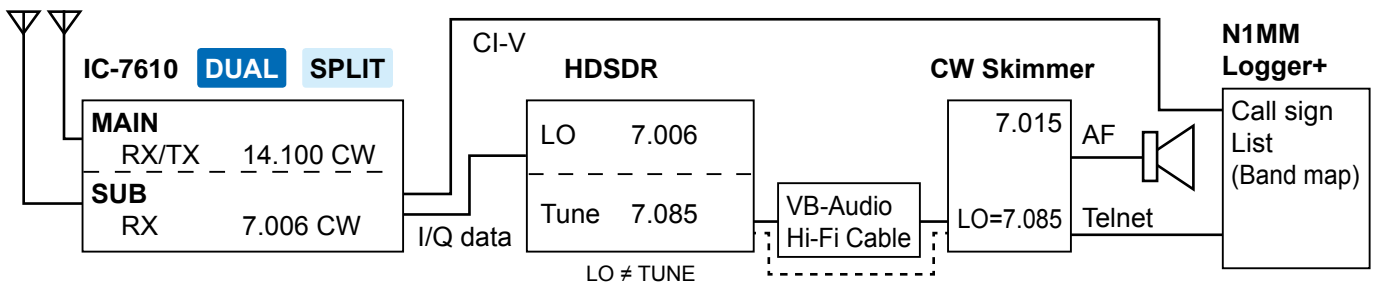

**TIP:**

Each application can be downloaded from the following websites.

- HSDR: <http://www.hdsdr.de/>
- CW Skimmer: <http://www.dxatlas.com/CwSkimmer/>
- VB-Audio Hi-Fi Cable: <https://www.vb-audio.com/Cable/index.htm#DownloadASIOBridge>
- Null-modern emulator (com0com): <https://sourceforge.net/projects/com0com/?source=directory>
- N1MM Logger+ <https://n1mm.hamdocs.com/tiki-index.php>

**① Information**

- Icom has been checked the operations with these applications but does not guarantee their performance.
- These applications are not Icom products.
- The URL may change without notice or obligation. Check for the latest information.

# Installing “IC-7610 USB I/Q Package for HSDR”

## Updating the IC-7610 USB I/Q Package for HSDR (p. 6):

If you already have the package installed, you can download the latest version and update it by doing an overwrite installation.

### ◇ Downloading

1. Access the Icom website.  
<http://www.icom.co.jp/world/>
2. Click <Support>.



3. Click “Firmware Updates/Software Downloads.”



4. Check the IC-7610 in Model name and click “USB I/Q Package for HSDR (Version X.XX) and manuals.”
5. Read “Regarding this Download Service” carefully, and then click <Agree>.

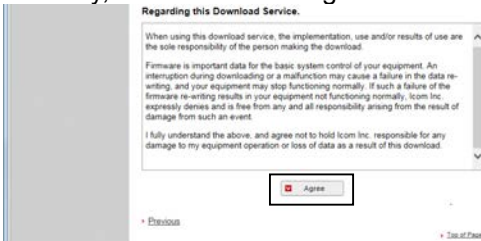

6. Click <Save as> in the displayed File Download dialog.
7. Select the location where you want to save the file, and then click <Save> in the displayed File Download dialog.
  - The file starts downloading.

### ◇ Unzipping the firmware folder

1. Right-click the downloaded firmware folder (zip format).
  - The Right-click menu is displayed.
2. Click “Extract All...”

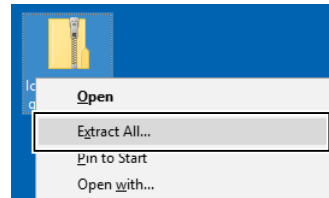

- After unzipping, a folder is created in the same location as the downloaded folder.
- ① The unzipped folder contains “setup32.exe” and “setup64.exe.”

## ◇ Installing

These instructions are based on Windows 10.

1. Double-click "setup32.exe" or "setup64.exe" contained in the unzipped folder, depending on your PC's OS type.

### ① Information

- "setup32.exe" is for a 32 bit operating system. "setup64.exe" is for a 64 bit operating system.
- You can select whether or not to display the file extensions in the Folder Options screen.
- If "User Account Control" is displayed, click <Yes> to continue.

2. Select a language and then click <OK>.

① In this document, "English" is selected.

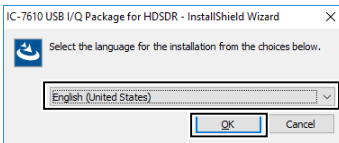

3. Click <Next>>.

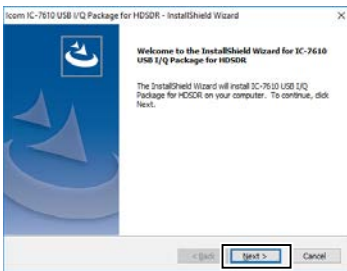

4. Confirm the destination folder, and then click <Next>>.

① If you change the HDSDR installed folder and install HDSDR, click <Browse...> and select the HDSDR installed folder.

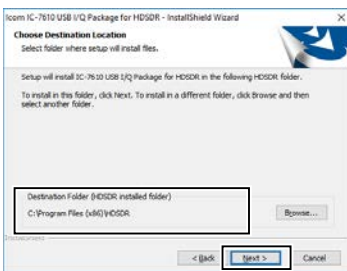

5. Click <Install>.

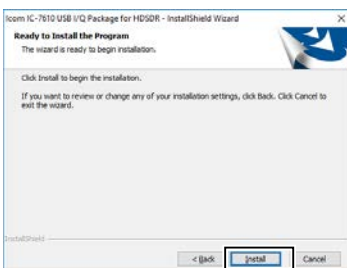

6. When the Windows Security screen is displayed, click <Install>.
7. Click <Finish>.

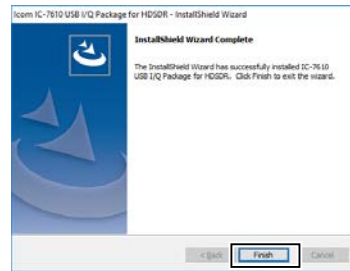

**NOTE:** You can uninstall the package using the "Apps & features" in the "System" menu. To get started, click on Start > Settings > System > Apps & features.

### **NOTE: About the overwrite installation**

If you already have the package installed, you can update it by following the procedure below.

① BE SURE to turn OFF the IC-7610 and quit the HDSDR application before doing an overwrite installation.

1. Double-click "setup32.exe" or "setup64.exe" contained in the unzipped folder, depending on your PC's OS type (as described in step 1 in the column to the left).
  - A confirmation dialog "This setup will perform an upgrade of 'IC-7610 USB I/Q Package for HDSDR.' Do you want to continue?" is displayed.
2. Click <Yes>, then follow the instructions displayed in the window.
  - ① You cannot change the language or destination folder.

## Connecting the IC-7610 to a PC

Connect a USB cable (USB 3.0, User supplied) from the IC-7610's [USB 2] to one of the PC's USB ports.

① When you connect a USB cable for the first time, a PC starts installing the driver after turning ON the IC-7610.

### NOTE:

- **DO NOT** connect the IC-7610 to a PC through any USB hub.
- Depending on the length of a USB cable, the transceiver may not operate properly even if it is recognized by the PC. Use as short a cable as possible.

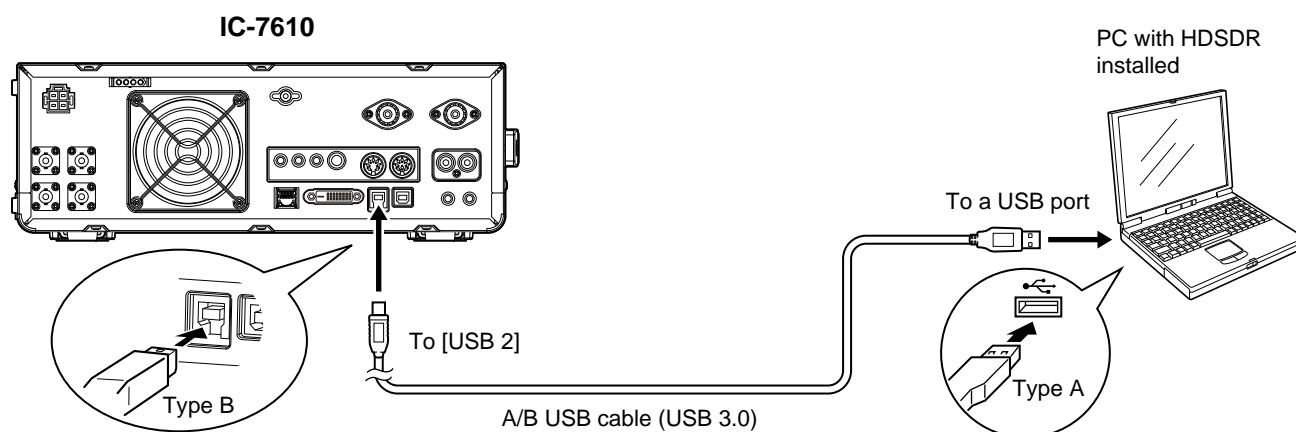

### ◇ Confirming that the driver has been successfully installed

After the installation has been completed, use the PC's Device Manager to confirm that the driver has been successfully installed.

#### To open the Device Manager screen

##### Windows 10

1. Click the folder icon on the taskbar.
2. Right-click "This PC," and then click "Properties."
3. Click "Device Manager."

##### Windows 8.1

1. Click the folder icon on the taskbar.
2. Right-click "This PC," and then click "Properties."
3. Click "Device Manager."

##### Windows 7

1. Click the folder icon on the taskbar.
2. Right-click "Computer," and then click "Properties."
3. Click "Device Manager."

#### To confirm the driver

1. Open the Device Manager screen.
  - ① If "User Account Control" is displayed, click <Yes>.
2. Confirm that "IC-7610 I/Q OUT Port" is displayed.
  - ① Windows 10, 8.1, 7:  
Double-click "Universal Serial Bus controllers."

**NOTE:** If "IC-7610 I/Q OUT Port" is not displayed, the driver may not have been properly installed. Install the driver again.  
→Installing "IC-7610 USB I/Q Package for HSDR."  
(pp. 5 ~ 6)

◇ Using HSDR with CW Skimmer (For a wide\* bandwidth)

\* Approximately 170 kHz

When you want to use N1MM Logger+ and CW Skimmer to check the wide band, connect another USB cable (User supplied) between the IC-7610's [USB 1] and a PC's USB port.

**NOTE:** Depending on the length of a USB cable, the transceiver may not operate properly, even if it is recognized by the PC. Use as short a cable as possible.

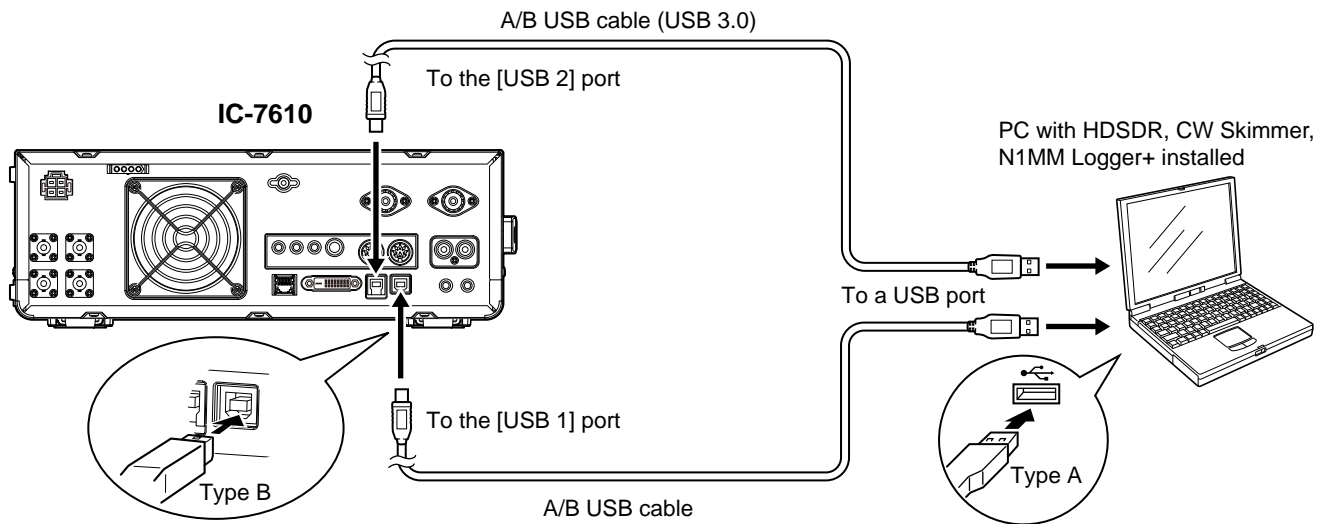

**TIP: For the [USB 1] connection**

If you have not connected a USB cable between the IC-7610 [USB 1] and your PC, download the required USB driver and the installation guide from the Icom website.



# IC-7610 HSDR Operating Guide

**These instructions describe how to use the HSDR application.**

- ① Before reading this guide, read “Preparations for the IC-7610 to be used as an SDR,” which can be downloaded from the Icom website, for details on how to install the software and connect the IC-7610 to HSDR.
- ① These instructions are based on using:
  - Microsoft® Windows® 10
  - IC-7610 USB I/Q Package for HSDR
  - HSDR version 2.76a
  - CW Skimmer version 2.0
  - VB-Audio Hi-Fi Cable version 1.0.0.7
  - Null-modem emulator (com0com) version 3.0.0.0
  - N1MM Logger+ version 1.0.7230.0

## Table of contents

<b>Starting up HSDR</b> .....	<b>2</b>
<b>HSDR Main screen</b> .....	<b>2</b>
<b>A. Using the IC-7610 with HSDR</b> .....	<b>3</b>
◇ Operation .....	3
◇ Settings.....	3
◇ Action.....	3
<b>B. Using HSDR as a 3rd receiver</b> .....	<b>4</b>
◇ Operation .....	4
◇ Settings.....	5
◇ Action.....	5
<b>C. Using CW Skimmer with HSDR (For a narrow 24 kHz bandwidth)</b> .....	<b>6</b>
◇ Operation: Making a call to a station that is decoded on CW Skimmer.....	6
◇ Settings: Making a call to a station that is decoded on CW Skimmer.....	6
◇ Action: Making a call to a station that is decoded on CW Skimmer.....	10
◇ Operation: Making a call to a station that is in the Split operation and in a pile up.....	11
◇ Settings: Making a call to a station that is in the Split operation and in a pile up .....	12
◇ Action: Making a call to a station that is in the Split operation and in a pile up .....	15
◇ Operation: Checking the CW band on CW Skimmer while communicating in the SSB mode .....	16
◇ Settings: Checking the CW band on CW Skimmer while communicating in the SSB mode .....	17
◇ Action: Checking the CW band on CW Skimmer while communicating in the SSB mode .....	20
◇ Troubleshooting .....	21
<b>D. Using CW Skimmer with HSDR (For a wide* bandwidth)</b> .....	<b>22</b>
◇ Operation .....	22
◇ Settings.....	23
◇ Action.....	27
<b>HSDR setting notes</b> .....	<b>28</b>
◇ Tune fixed to 'LO <-> Tune Offset'.....	28
◇ The Lock function .....	28
<b>IC-7610 I/Q Settings screen</b> .....	<b>29</b>
<b>USB Dial Settings screen</b> .....	<b>30</b>
<b>Using the RC-28</b> .....	<b>30</b>

Icom, Icom Inc. and Icom logo are registered trademarks of Icom Incorporated (Japan) in Japan, the United States, the United Kingdom, Germany, France, Spain, Russia, Australia, New Zealand, and/or other countries.

Microsoft and Windows are registered trademarks of Microsoft Corporation in the United States and/or other countries.

HSDR is the property of Mr. Mario Täeubel (DG0JBJ).

CW skimmer is the property of Afreet Software, Inc.

Null-modern emulator (com0com) is an open source software based on the GPLv2 license.

VB-Audio Hi-Fi Cable is the property of Mr. Vincent Burel.

N1MM Logger+ is the property of Mr. Thomas F Wagner (N1MM).

All other products or brands are registered trademarks or trademarks of their respective holders.

# Starting up HSDR

1. Turn ON the IC-7610.
2. Double-click HSDR icon to start up HSDR.



① If you have installed two or more ExtIO-DLL files, the screen below is displayed. To open the HSDR Main screen, select "ExtIO\_IC7610.dl," and then click <Open>.

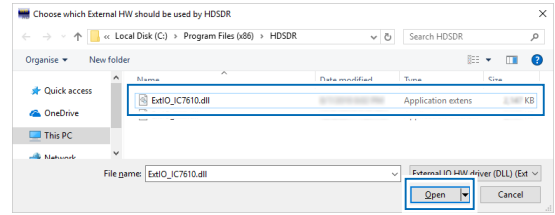

## HSDR Main screen

These are parts of the HSDR operations. Check the detailed HSDR operations on the Internet.  
 ① These screens are examples.

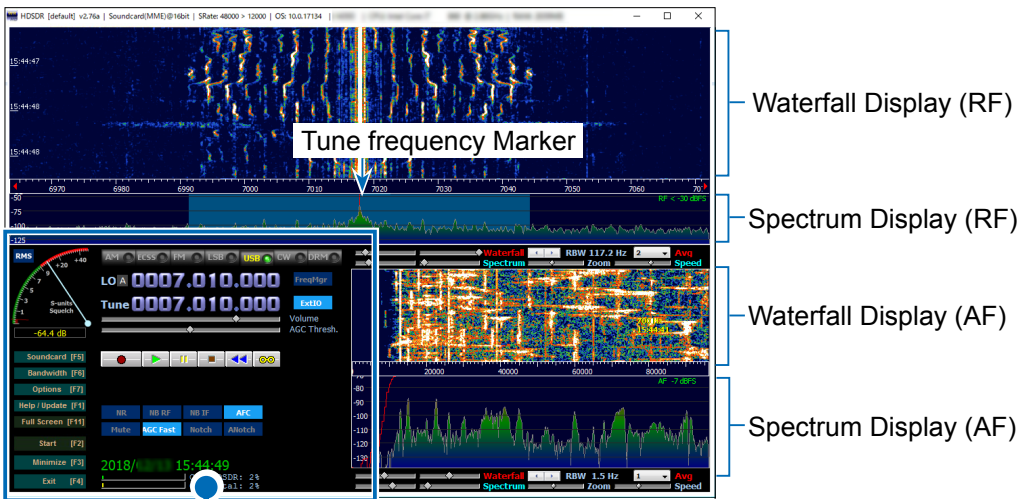

- Waterfall Display (RF)
- Spectrum Display (RF)
- Waterfall Display (AF)
- Spectrum Display (AF)

Click to set the HSDR Tune frequency.  
 Click to set the IC-7610 operating frequency.  
 Click to select the operating mode.



Click to display the Sound Card Selection screen.

Click to select the sampling rate.

① The required output sampling rate depends on the operating mode.

Click to start or stop operating.

Click to quit the application.

Click to display the IC-7610 I/Q Settings screen. (p. 29)

Slide to adjust the audio level.

# A. Using the IC-7610 with HSDR

## ◇ Operation

1. Set the HSDR LO frequency so that it is near the frequency you want to monitor.
2. Set the HSDR Tune frequency to the frequency you want to monitor.
  - The demodulated signal is output from the speaker.

**TIP:** You can hear the audio by changing only the Tune frequency without changing the LO frequency, if the frequency is within the I/Q range\*.

\* Sampling Rate range on the IC-7610 I/Q Settings screen. For example, if Sampling Rate is set to “1.92 MHz,” the I/Q range is 1.66 MHz wide.

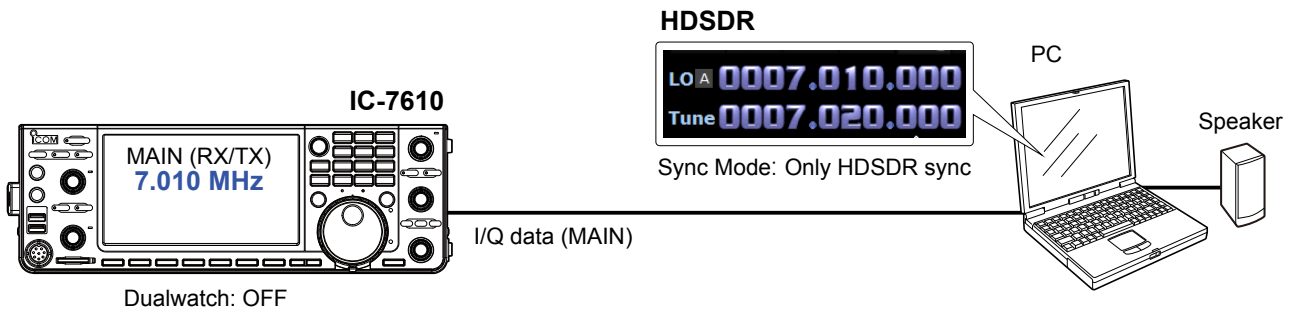

## ◇ Settings

1. Click <Ext IO> to display the IC-7610 I/Q Settings screen. Set the items as described below.
  - MAIN/SUB:** MAIN or SUB
  - Sync Mode:** Only HSDR sync
2. Click <Soundcard> to confirm that the speaker in use is selected.
3. Click <Bandwidth> to set **Output Sampling Rate [Hz]** to “12000.”
  - ① “48000” or lower is recommended. When you operate in the SSB mode, “12000” is adequate.



**TIP:** If the audio is not heard from the speaker, click <Options> and confirm that **Output Channel Mode for RX** is set to “AF to Both channels (default).”

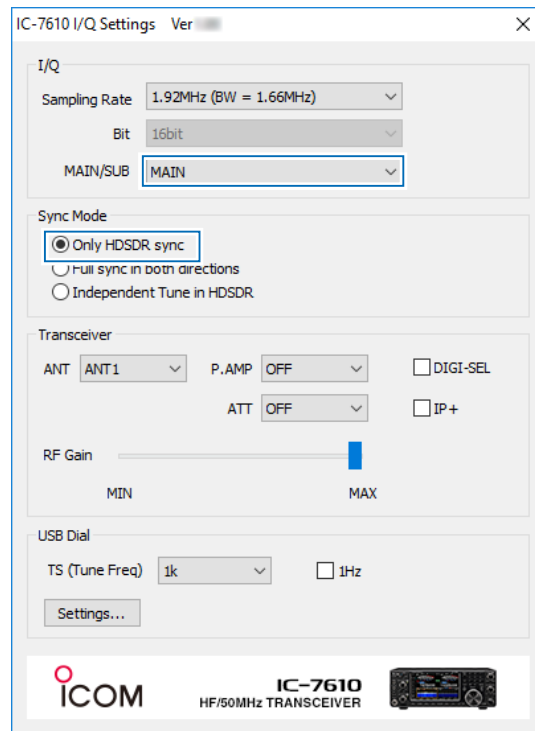
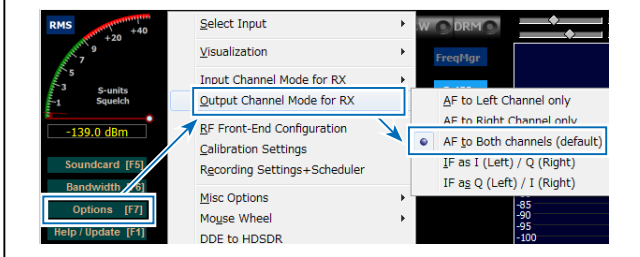

## ◇ Action

When changing the IC-7610 operating frequency or the HSDR LO frequency, the HSDR Tune frequency is changed based on the LO frequency.

- ① The HSDR LO is synchronized with the IC-7610’s operating frequency.
- ② You cannot set the HSDR LO frequency out of the IC-7610’s available frequency range.

## B. Using HSDR as a 3rd receiver

### ◇ Operation

1. Set the IC-7610 operating frequency.
  - The HSDR LO frequency is linked to the IC-7610 operating frequency.
2. Set the HSDR Tune frequency as a 3rd receiver frequency within the I/Q range.

#### ① Information

- The HSDR Tune frequency is independent and is not changed, even if you change the IC-7610 operating frequency.
- Turn ON the Dualwatch function when connecting HSDR to the IC-7610 SUB band.
- The I/Q range\* is limited (up to 1.92 MHz wide) so you can only receive the same band as the IC-7610 operating frequency.

\* Sampling Rate range on the IC-7610 I/Q Settings screen. For example, if Sampling Rate is set to "1.92 MHz," the I/Q range is 1.66 MHz wide.

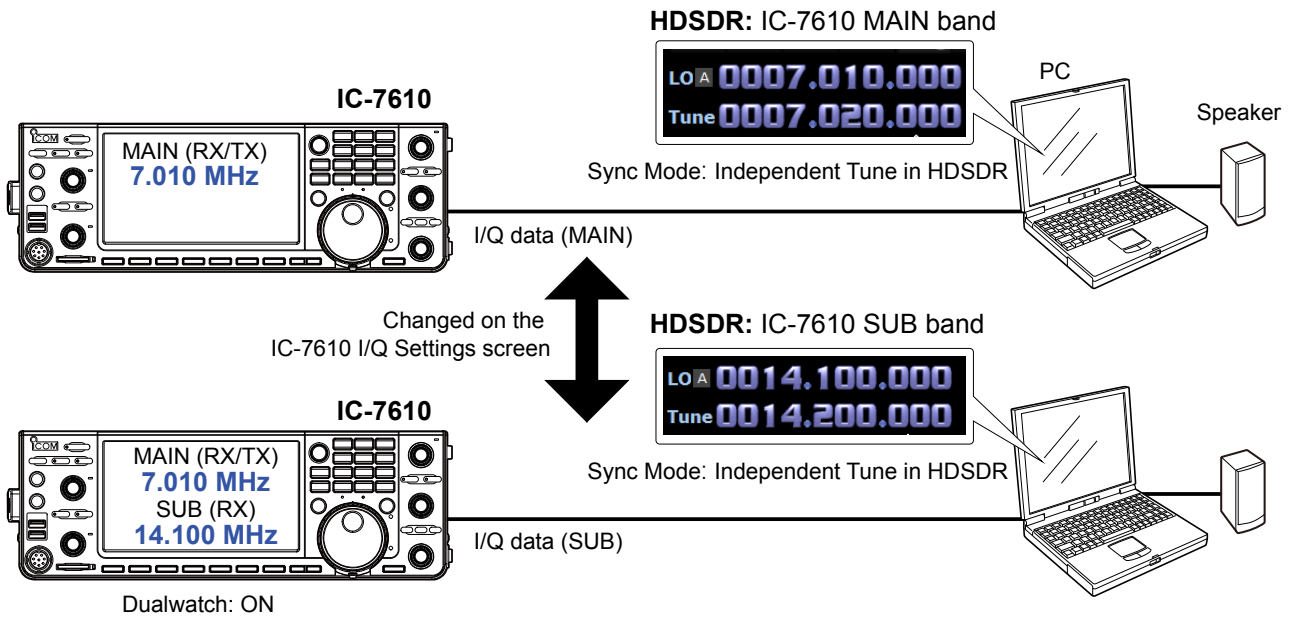

### ◇ Settings

- Click <Ext IO> to display the IC-7610 I/Q Settings screen. Set the items as described below.  
**MAIN/SUB:** MAIN or SUB  
**Sync Mode:** Independent Tune in HSDR
- Click <Soundcard> to confirm that the speaker in use is selected.
- Click <Bandwidth> to set **Output Sampling Rate [Hz]** to “12000.”  
 ① “48000” or lower is recommended. When you operate in the SSB mode, “12000” is adequate.

**TIP:** If the audio is not heard from the speaker, click <Options> and confirm that **Output Channel Mode for RX** is set to “AF to Both channels (default).”

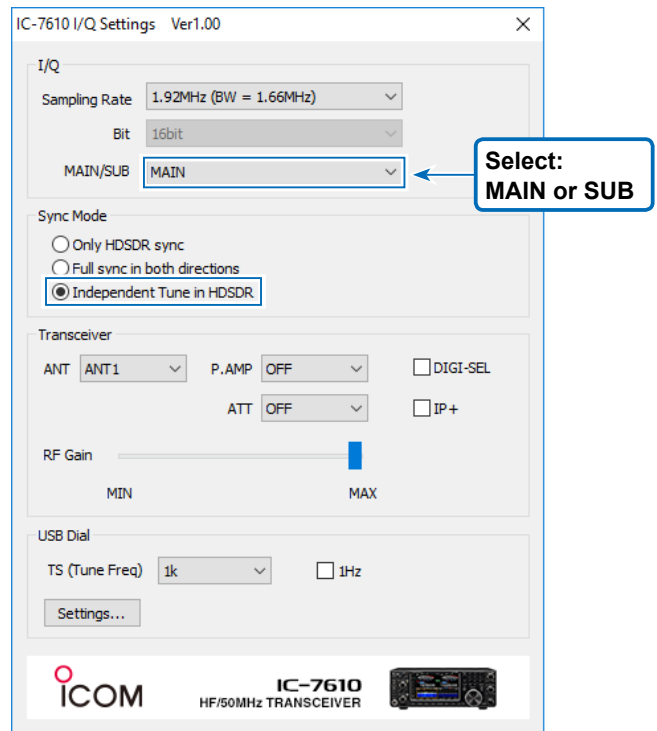
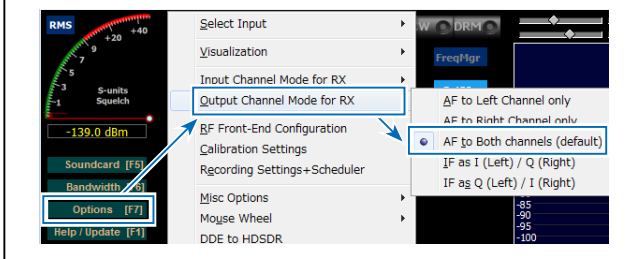

### ◇ Action

Even if you change the IC-7610 operating frequency or the HSDR LO frequency, the HSDR Tune frequency is not changed. Therefore, you can receive on a frequency that is different from the IC-7610.

- ① The audio output from HSDR may be interrupted while changing the IC-7610 operating frequency.
- ① You cannot set the HSDR LO frequency out of the IC-7610's available frequency range.

## C. Using CW Skimmer with HSDR (For a narrow 24 kHz bandwidth)

### ◇ Operation: Making a call to a station that is decoded on CW Skimmer

1. Select the CW mode on the IC-7610.
2. Set the operating frequency to where (within  $\pm 12$  kHz) a station is calling a CQ.
3. Click on a station decoded on CW Skimmer.
  - The operating frequency is automatically set.
4. Transmit on the frequency and make a call to the station.
  - The IC-7610 operating frequency, the HSDR LO frequency, the HSDR Tune frequency, and the CW Skimmer frequency are set to the same frequency.

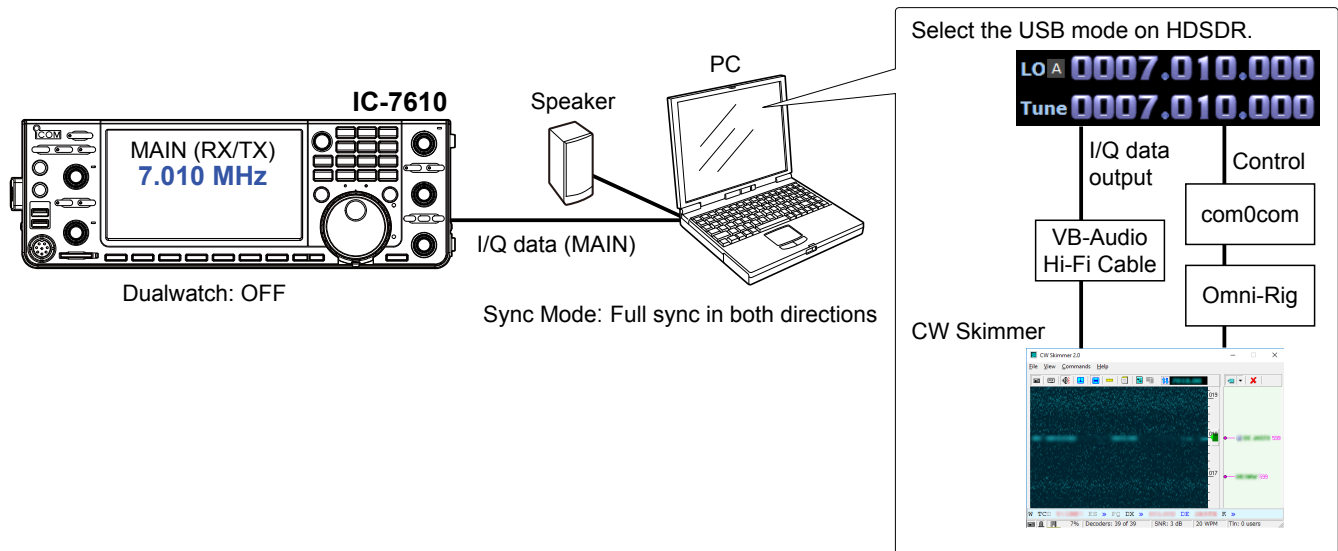

### ① Information

- You can not hear the demodulated audio from HSDR because HSDR in this case is used for only I/Q data conversion.
- You can hear the demodulated audio of the operating frequency from CW Skimmer which is the same audio as the IC-7610.
- The I/Q data output from HSDR is input to CW Skimmer through VB-Audio Hi-Fi Cable.
- CW Skimmer uses Omni-Rig to connect to com0com and controls the HSDR Tune frequency through the virtual serial port of com0com.

### ◇ Settings: Making a call to a station that is decoded on CW Skimmer

**NOTE:** First, setup com0com and VB-Audio Hi-Fi Cable before setting up HSDR. The setup is required only for the first time.

#### com0com

**TIP:** If the COM port numbers are between COM 1 and COM 20 as the default, you do not have to follow the steps below.

1. Open the Windows Start menu and click "com0com" → "Setup."
  - Setup for com0com window is displayed.
2. Select 2 COM port numbers that are not used. (Example: COM 10 and COM 11)
  - ① DO NOT select the numbers larger than COM 20. Omni-Rig cannot support them.
  - ① If the COM port number is displayed in red, the number is currently used for other devices. Change the number.
3. Click <Apply> and close the screen.
  - ① If the Program Compatibility Assistant screen is displayed, click <Cancel>.

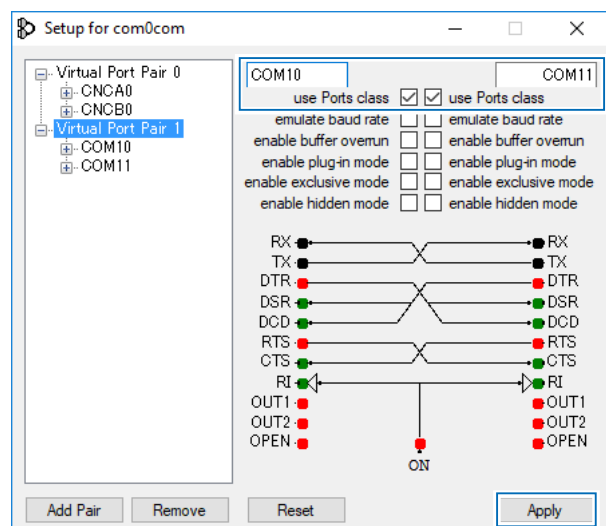

◇ Settings: Making a call to a station that is decoded on CW Skimmer (continued)

### VB-Audio Hi-Fi Cable

1. From the desktop, right-click your taskbar's Speaker icon and select "Recording device."
2. Click the "Recording" tab.
3. Select "Hi-Fi Cable Output" from the list and click <Properties>.

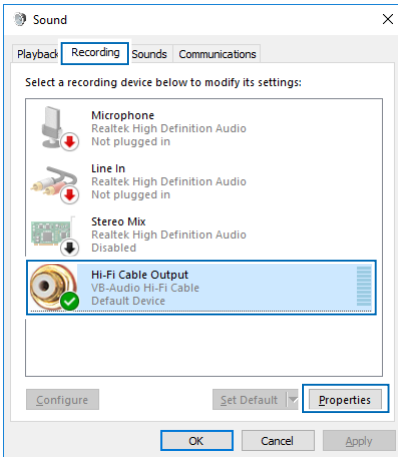

4. Click the "Advanced" tab.
5. Set "Default Format" to "2 channel, 16 bit, 192000 Hz," and then click <OK>.

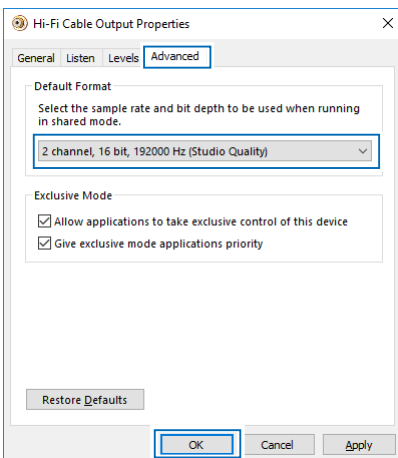

6. Click the "Playback" tab.
7. Select "Hi-Fi Cable Input" from the list and click <Properties>.
8. Click the "Advanced" tab.
9. Set "Default Format" to "16 bit, 192000 Hz," and then click <OK>.

◇ Settings: Making a call to a station that is decoded on CW Skimmer (continued)

**HSDR**

1. Set the operating mode to “USB.”
2. Click <Ext IO> to display the IC-7610 I/Q Settings screen. Set the items as described below.

**MAIN/SUB:** MAIN

**Sync Mode:** Full sync in both directions.

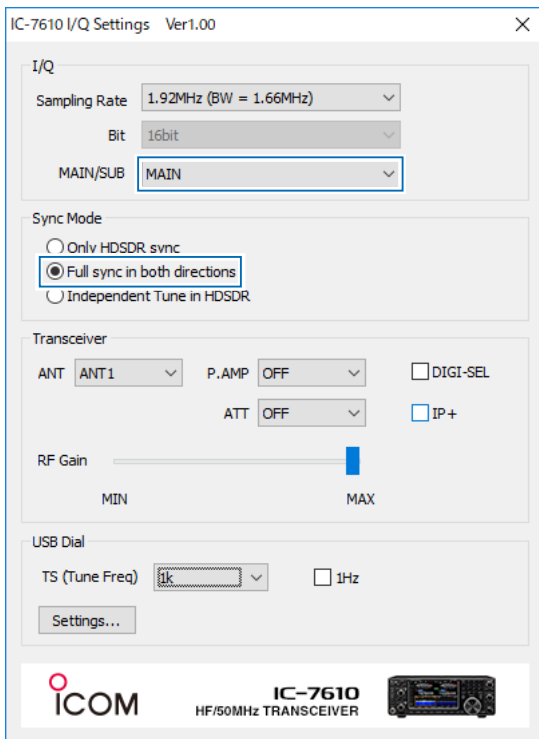

3. Click <Soundcard> to display the Sound Card Selection screen. Select “Hi-Fi Cable Input” to output I/Q data from HSDR.

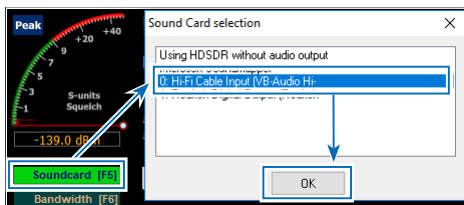

4. Click <Bandwidth> to set **Output Sampling Rate [Hz]** to “192000.”

5. Click <Options> and set **Output Channel Mode for RX** to “IF as I (Left) / Q (Right).”

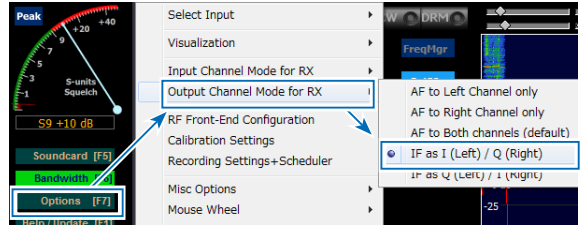

IQ-Gain setting is displayed on the HSDR Main screen.

- ① Normally “0dB” is used but you can adjust the gain level according to your situation. (p. 21)



6. Click <Options> and set the items as described below.

- Click “CAT to HSDR” → “Port” and select a COM port that is set in com0com.
- Click “CAT to HSDR” and select “activated.”

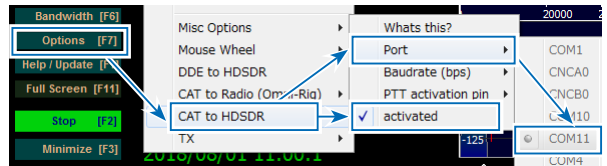



◇ Settings: Making a call to a station that is decoded on CW Skimmer (continued)

**CW Skimmer**

1. To input I/Q data to the CW Skimmer, click <View> → <Settings> → the “Radio” tab, and then set the items as described below.

**Hardware Type:** SoftRock-IF  
**Sampling Rate:** 192 kHz

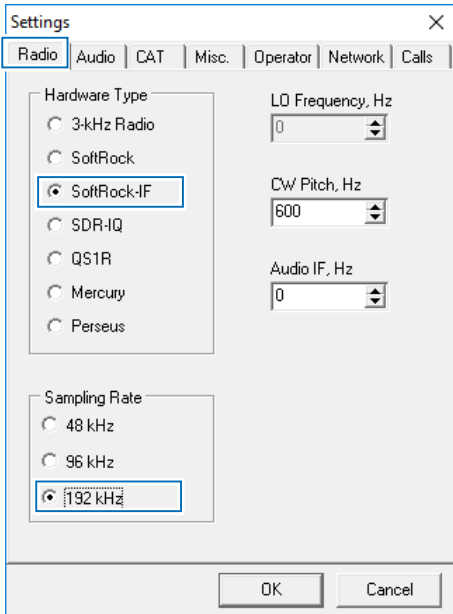

2. To input the I/Q data and output the demodulated audio on the CW Skimmer to the speaker, click the “Audio” tab, and then set the items as described below.

**Signal I/O Device:** Hi-Fi Cable Output  
**Audio I/O Device:** A speaker connected to your PC

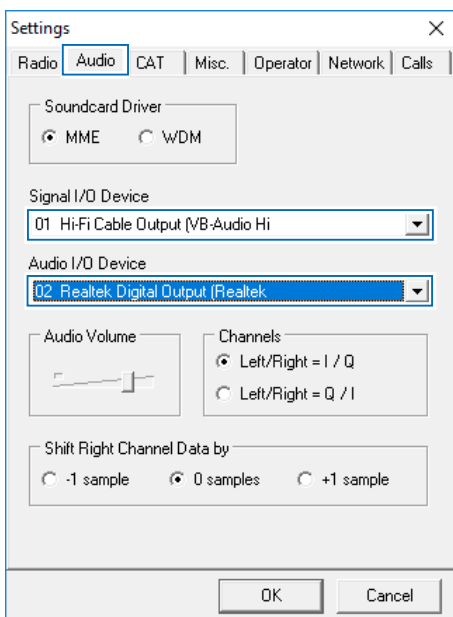

3. To control the frequency synchronization, click the “CAT” tab, and then set the items as described below.

**CAT Interface:** Use Radio 1

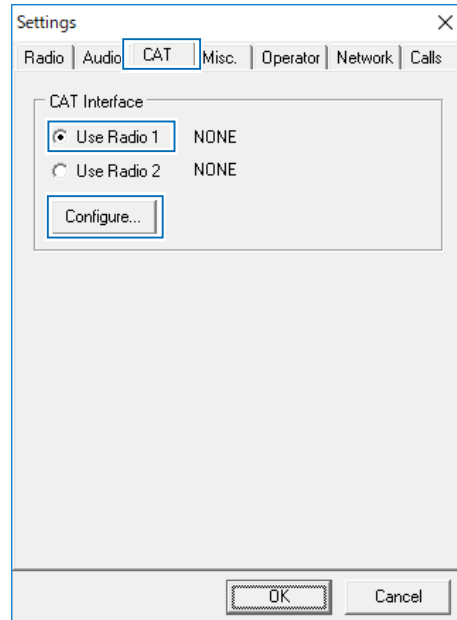

4. Click <Congifure...> to open Omni-Rig Settings screen, and then set the items as described below.

**Rig type:** Kenwood  
**Port:** Select the COM Port that is in com0com, and not set in HSDR.  
**Poll int. ms:** 100  
**Timeout. ms:** 100

① For other settings, see the screen below.

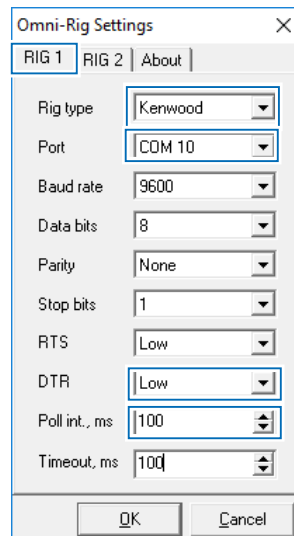

**TIP:** You can check the required settings on the HSDR Main screen.  
 <Options> → <CAT to HSDR> → <What’s this ?>

◇ Action: Making a call to a station that is decoded on CW Skimmer

Click <Start> on the HSDR Main screen, and then click <Start> on the CW Skimmer's tool bar.

- The waveform is displayed on CW Skimmer.
- The IC-7610 operating frequency, the HSDR LO frequency, the HSDR Tune frequency, and the CW Skimmer frequency are set to the same frequency.
- ① When changing the frequency, all frequencies are synchronized. Clicking on the signal or the call sign on CW Skimmer sets the operating frequency to the IC-7610 MAIN band.
- ① Right after the frequencies are changed, the waveform on CW Skimmer may be disturbed. However, after few seconds, the waveform is correctly displayed.

CW Skimmer

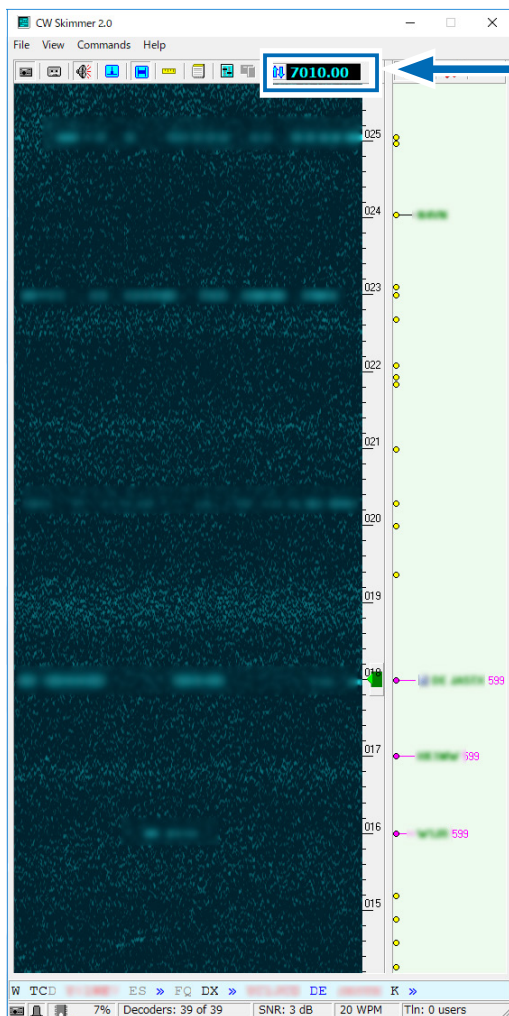

HSDR

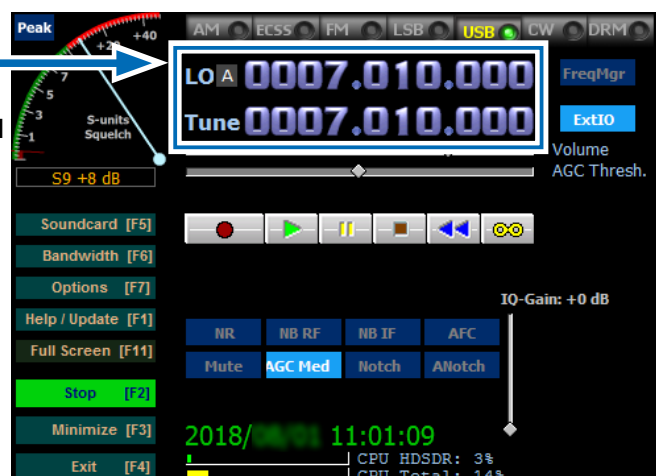

All synchronized

IC-7610

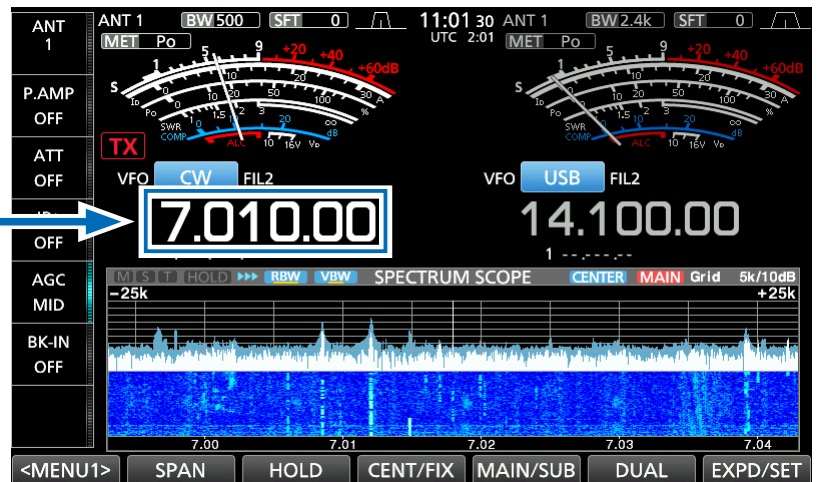

◇ **Operation: Making a call to a station that is in the Split operation and in a pile up**

When a station sends “599” to a station that is in the Split operation and in a pile up, you notice the frequency the station in a pile up receives, using CW Skimmer.

1. Select the CW mode and on the IC-7610 MAIN band and receive the signal of a station in a pile up.  
(Example: 7.010 MHz)
2. Select the CW mode and on the IC-7610 SUB band and set the operating frequency near the receive frequency of the station in a pile up. (Example: 7.015 MHz)
3. Turn ON the Split function on the IC-7610.
4. Turn ON the Dualwatch function on the IC-7610 and start HSDR and CW Skimmer.
  - The I/Q data is input from the IC-7610 SUB band to HSDR.
5. Click on the displayed signal that may be used by the station in a pile up on CW Skimmer.
  - The frequency is set to the IC-7610 SUB band.
  - The IC-7610 SUB band operating frequency, the HSDR LO frequency, the HSDR Tune frequency, and the CW Skimmer frequency are set to the same frequency.
6. Transmit to the station on the IC-7610 SUB band.
  - ① Your signal is transmitted on the SUB band.

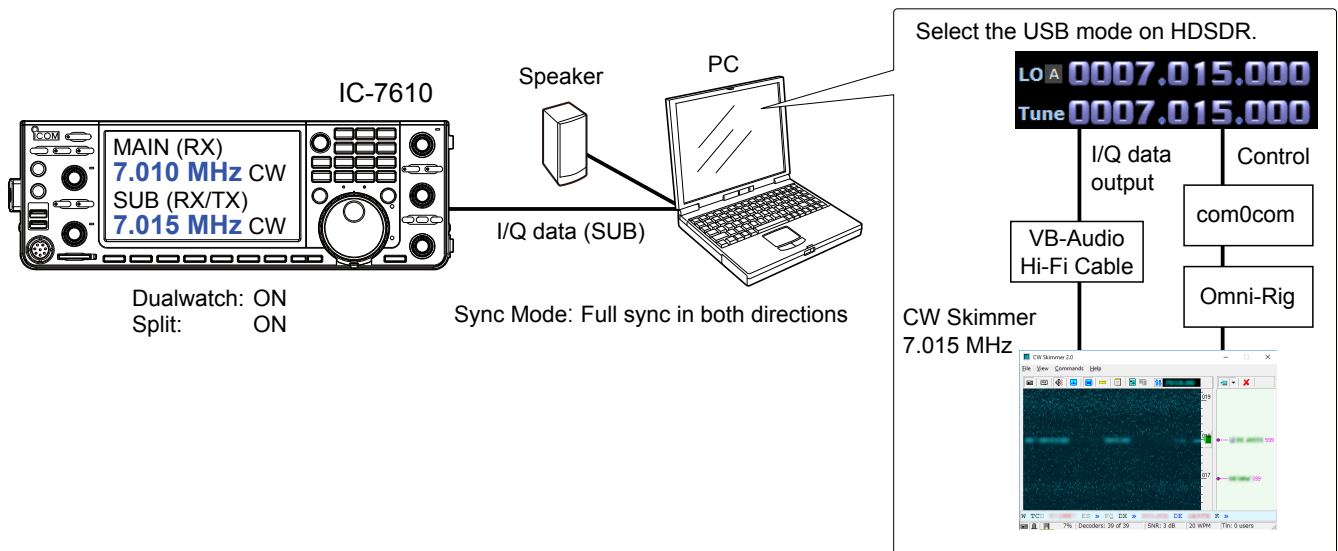

① **Information**

- You can not hear the demodulated audio from HSDR because HSDR in this case is used for only I/Q data conversion.
- You can hear the demodulated audio of the operating frequency from CW Skimmer which is the same audio as the IC-7610.
- The I/Q data output from HSDR is input to CW Skimmer through VB-Audio Hi-Fi Cable.
- CW Skimmer uses Omni-Rig to connect to com0com and controls the HSDR Tune frequency through the virtual serial port of com0com.

◇ **Settings: Making a call to a station that is in the Split operation and in a pile up**

**NOTE:** First, setup com0com and VB-Audio Hi-Fi Cable before setting up HSDR. The setup is required only for the first time.

**com0com**

**TIP:** If the COM port numbers are between COM 1 and COM 20 as the default, you do not have to follow the steps below.

1. Open the Windows Start menu and click “com0com” → “Setup.”
  - Setup for com0com window is displayed.
2. Select 2 COM port numbers that are not used. (Example: COM 10 and COM 11)
  - ① DO NOT select the numbers larger than COM 20. Omni-Rig cannot support them.
  - ① If the COM port number is displayed in red, the number is currently used for other devices. Change the number.
3. Click <Apply> and close the screen..
  - ① If the Program Compatibility Assistant screen is displayed, click <Cancel>.

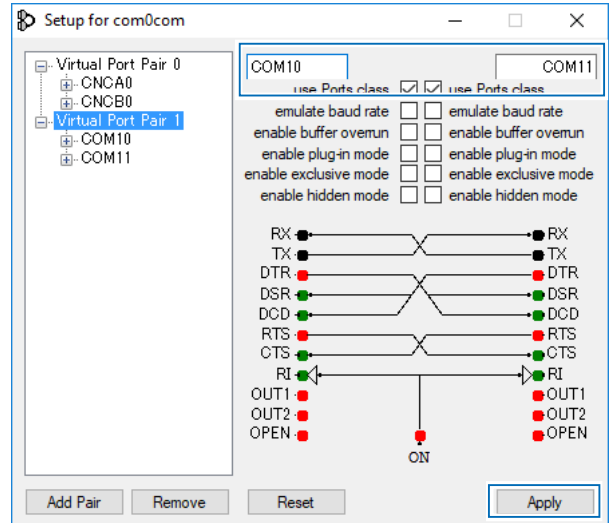

**VB-Audio Hi-Fi Cable**

1. From the desktop, right-click your taskbar’s Speaker icon and select “Recording device.”
2. Click the “Recording” tab.
3. Select “Hi-Fi Cable Output” from the list and click <Properties>.

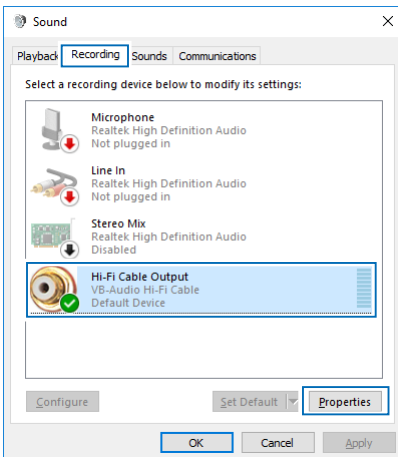

4. Click the “Advanced” tab.

5. Set “Default Format” to “2 channel, 16 bit, 192000 Hz,” and then click <OK>.

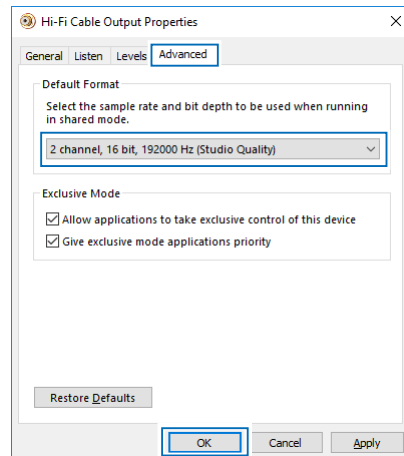

6. Click the “Playback” tab.
7. Select “Hi-Fi Cable Input” from the list and click <Properties>.
8. Click the “Advanced” tab.
9. Set “Default Format” to “16 bit, 192000 Hz,” and then click <OK>.

◇ Settings: Making a call to a station that is in the Split operation and in a pile up (continued)

## HSDR

1. Set the operating mode to “USB.”
2. Click <Ext IO> to display the IC-7610 I/Q Settings screen. Set the items as described below.

**MAIN/SUB:** SUB

**Sync Mode:** Full sync in both directions.

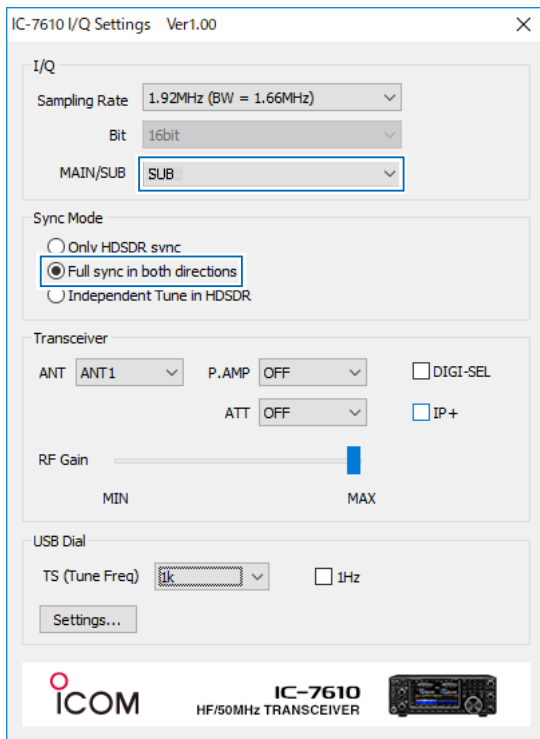
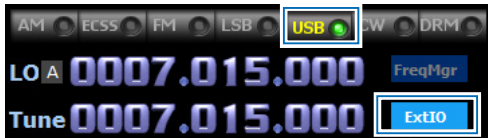

3. Click <Soundcard> to display the Sound Card Selection screen. Select “Hi-Fi Cable Input” to output I/Q data from HSDR.

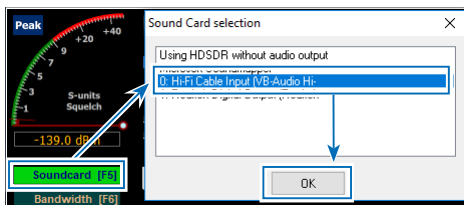

4. Click <Bandwidth> to set **Output Sampling Rate [Hz]** to “192000.”

5. Click <Options> and set **Output Channel Mode for RX** to “IF as I (Left) / Q (Right).”

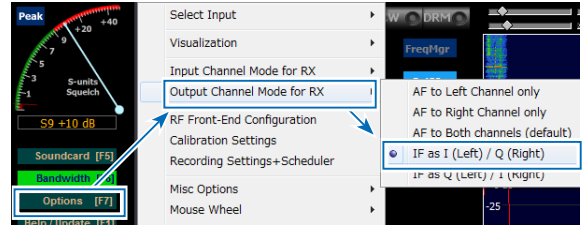

IQ-Gain setting is displayed on the HSDR Main screen.

- ① Normally “0dB” is used but you can adjust the gain level according to your situation. (p. 21)



6. Click <Options> and set the items as described below.

- Click “CAT to HSDR” → “Port” and select a COM port that is set in com0com.
- Click “CAT to HSDR” and select “activated.”

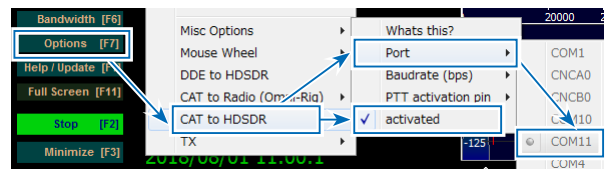

◇ Settings: Making a call to a station that is in the Split operation and in a pile up (continued)

**CW Skimmer**

1. To input I/Q data to the CW Skimmer, click <View> → <Settings> → the “Radio” tab, and then set the items as described below.

**Hardware Type:** SoftRock-IF  
**Sampling Rate:** 192 kHz

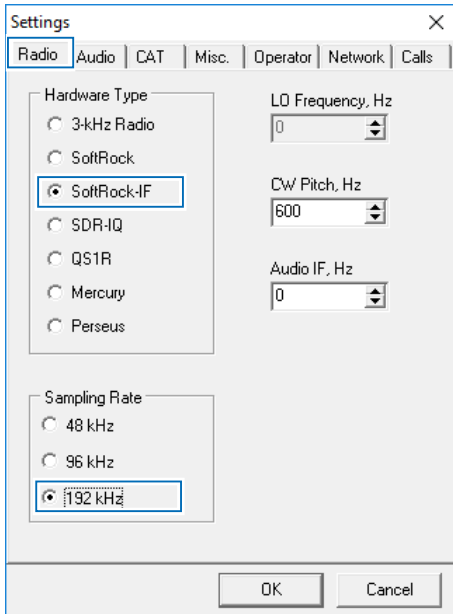

2. To input the I/Q data and output the demodulated audio on the CW Skimmer to the speaker, click the “Audio” tab, and then set the items as described below.

**Signal I/O Device:** Hi-Fi Cable Output  
**Audio I/O Device:** A speaker connected to your PC

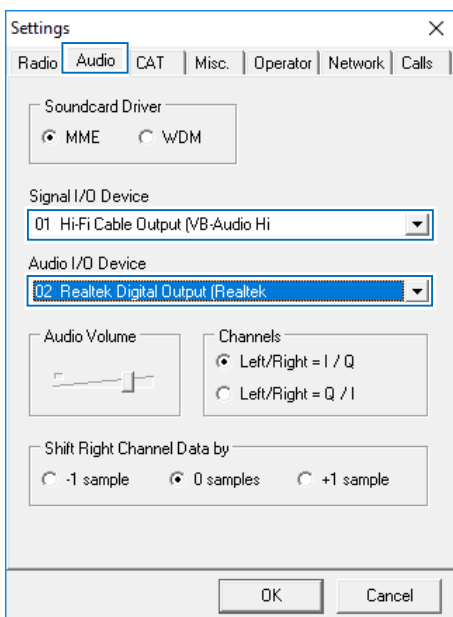

3. To control the frequency synchronization, click the “CAT” tab, and then set the items as described below.

**CAT Interface:** Use Radio 1

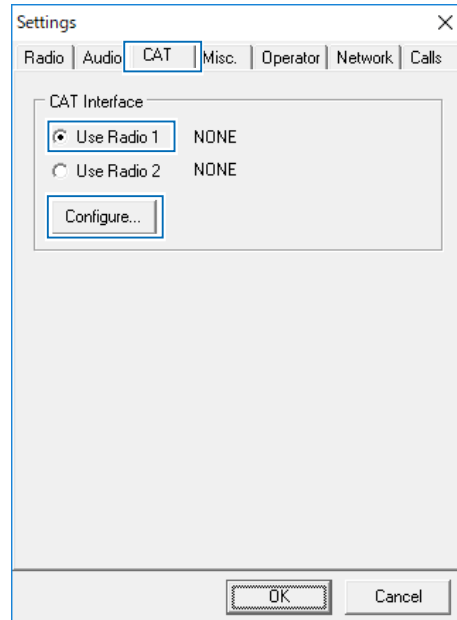

4. Click <Congifure...> to open the Omni-Rig Settings screen, and then set the items as described below.

**Rig type:** Kenwood  
**Port:** Select the COM Port that is in com0com, and not set in HSDR.  
**Poll int. ms:** 100  
**Timeout. ms:** 100

① For other settings, see the screen below.

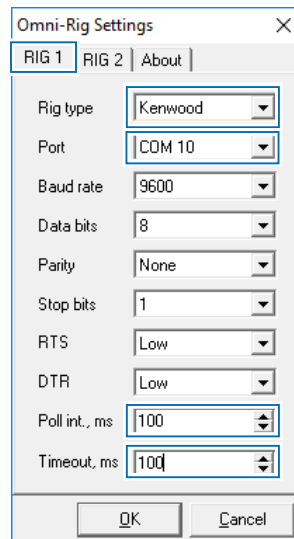

**TIP:** You can check the required settings on the HSDR Main screen.  
 <Options> → <CAT to HSDR> → <What’s this ?>

◇ Action: Making a call to a station that is in the Split operation and in a pile up

Click <Start> on the HSDR Main screen, and then click <Start> on the CW Skimmer's tool bar.

- The waveform is displayed on CW Skimmer.
- The IC-7610 SUB band operating frequency, the HSDR LO frequency, the HSDR Tune frequency, and the CW Skimmer frequency are set to the same frequency.
- ① When changing the frequency, all frequencies are synchronized. Clicking on the signal or the call sign on CW Skimmer sets the operating frequency to the IC-7610 SUB band.
- ① Right after the frequencies are changed, the waveform on CW Skimmer may be disturbed. However, after few seconds, the waveform is correctly displayed.

CW Skimmer

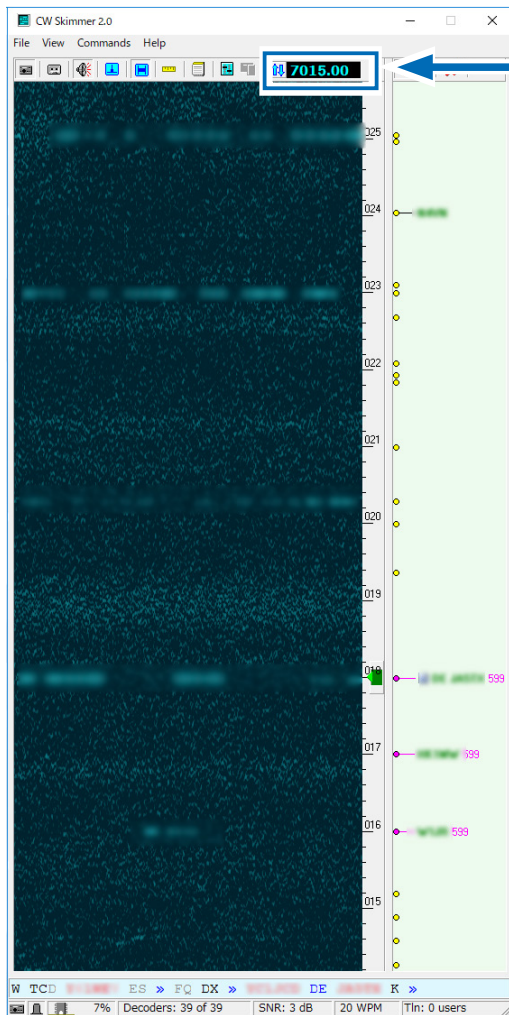

HSDR

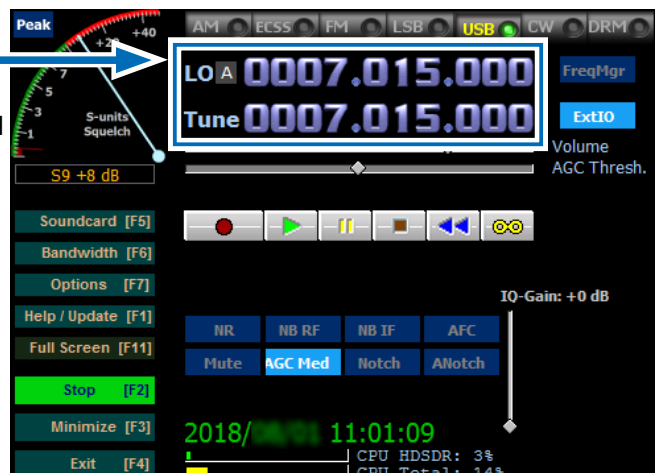

All synchronized

IC-7610

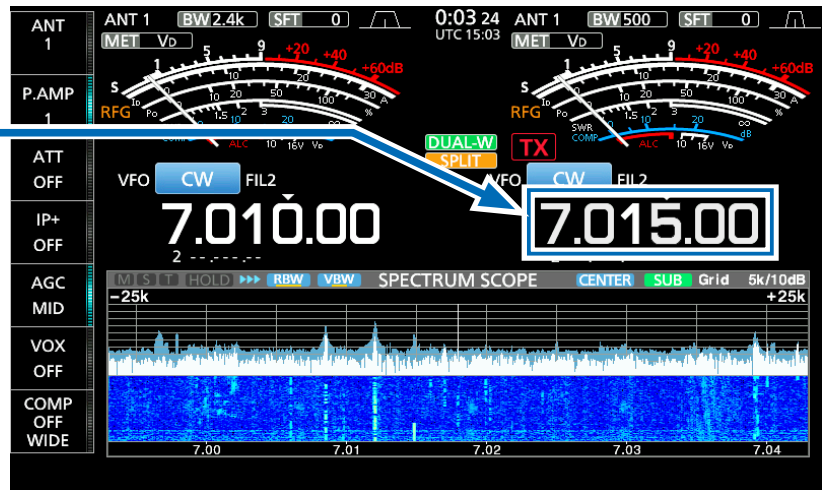

### ◇ Operation: Checking the CW band on CW Skimmer while communicating in the SSB mode

While communicating in the SSB mode, when a signal of the CW station you want to make a call to is decoded on CW Skimmer, turn ON the Split function on the IC-7610 to make a call.

① You can also use the same band and the same operating mode Dualwatch.

1. Select the SSB mode and set the receive frequency (14.200 MHz) on the IC-7610 MAIN band.
  - ① Communicate in the SSB mode until a target station appears.
2. Select the CW mode and set the transmit frequency (7.015 MHz) on the IC-7610 SUB band.
3. Turn ON the Dualwatch function on the IC-7610 and start HSDR and CW Skimmer.
  - The I/Q data is input from the IC-7610 SUB band to HSDR.
4. If a CW station you want to make a call is displayed on CW Skimmer, click the displayed signal.
  - The frequency is set to the IC-7610 SUB band.
  - The IC-7610 SUB band operating frequency, the HSDR LO frequency, the HSDR Tune frequency, and the CW Skimmer frequency are set to the same frequency.
5. Turn ON the Split function on the IC-7610 and transmit to the station on the IC-7610 SUB band.

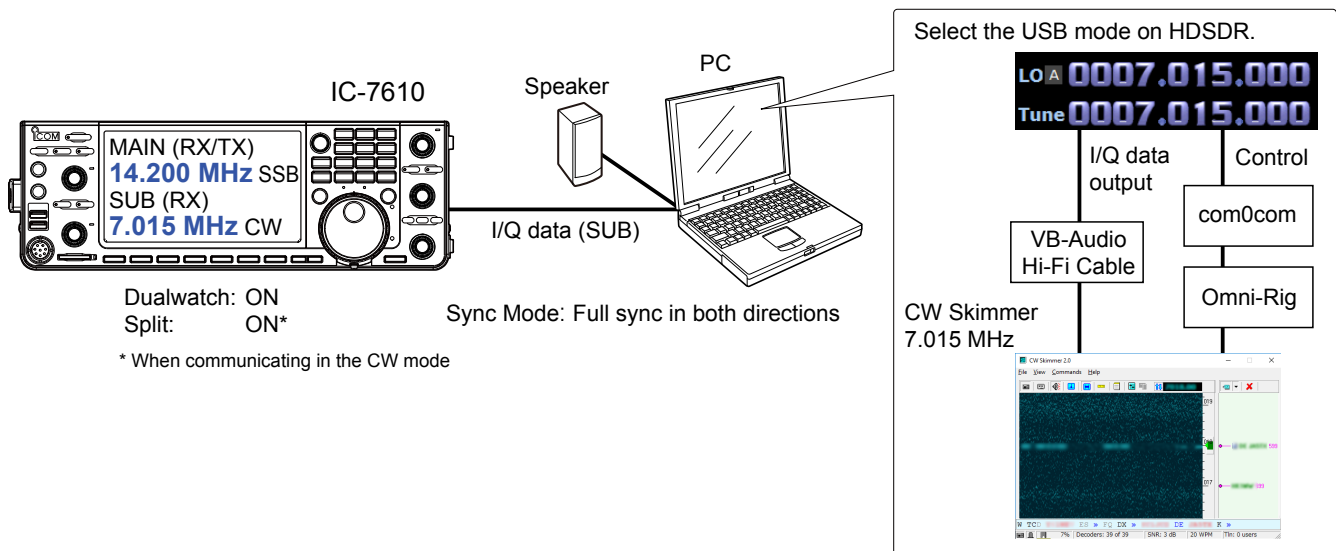

### ① Information

- You can not hear the demodulated audio from HSDR because HSDR in this case is used for only I/Q data conversion.
- You can hear the demodulated audio of the operating frequency from CW Skimmer which is the same audio as the IC-7610.
- The I/Q data output from HSDR is input to CW Skimmer through VB-Audio Hi-Fi Cable.
- CW Skimmer uses Omni-Rig to connect to com0com and controls the HSDR Tune frequency through the virtual serial port of com0com.



## ◇ Settings: Checking the CW band on CW Skimmer while communicating in the SSB mode

**NOTE:** First, setup com0com and VB-Audio Hi-Fi Cable before setting up HSDR. The setup is required only for the first time.

### com0com

**TIP:** If the COM port numbers are between COM 1 and COM 20 as the default, you do not have to follow the steps below.

1. Open the Windows Start menu and click "com0com" → "Setup."
  - Setup for com0com window is displayed.
2. Select 2 COM port numbers that are not used. (Example: COM 10 and COM 11)
  - ① DO NOT select the numbers larger than COM 20. Omni-Rig cannot support them.
  - ① If the COM port number is displayed in red, the number is currently used for other devices. Change the number.
3. Click <Apply> and close the screen..
  - ① If the Program Compatibility Assistant screen is displayed, click <Cancel>.

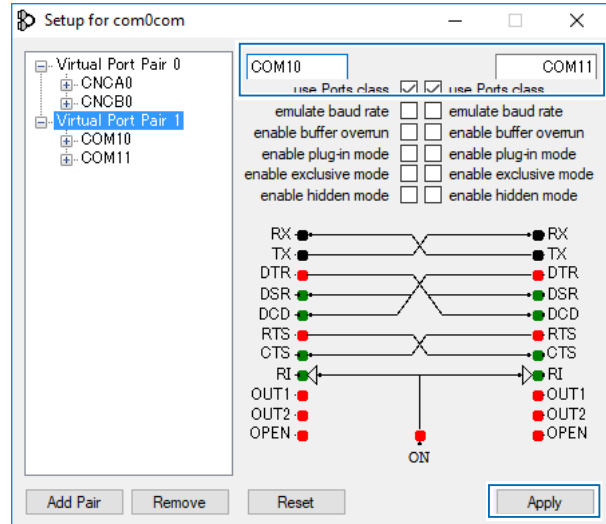

### VB-Audio Hi-Fi Cable

1. From the desktop, right-click your taskbar's Speaker icon and select "Recording device."
2. Click the "Recording" tab.
3. Select "Hi-Fi Cable Output" from the list and click <Properties>.

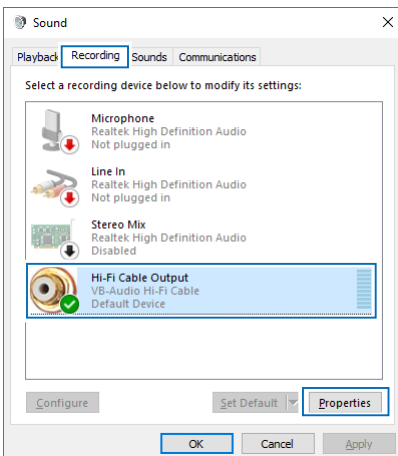

4. Click the "Advanced" tab.

5. Set "Default Format" to "2 channel, 16 bit, 192000 Hz," and then click <OK>.

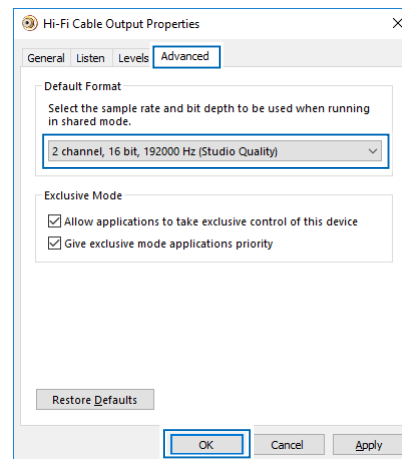

6. Click the "Playback" tab.
7. Select "Hi-Fi Cable Input" from the list and click <Properties>.
8. Click the "Advanced" tab.
9. Set "Default Format" to "16 bit, 192000 Hz," and then click <OK>.

◇ Settings: Checking the CW band on CW Skimmer while communicating in the SSB mode (continued)

## HSDR

1. Set the operating mode to “USB.”
2. Click <Ext IO> to display the IC-7610 I/Q Settings screen. Set the items as described below.

**MAIN/SUB:** SUB

**Sync Mode:** Full sync in both directions.

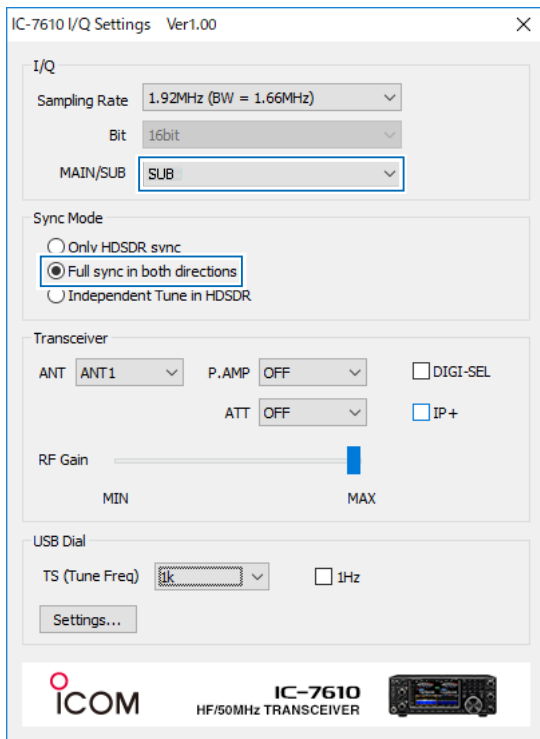

3. Click <Soundcard> to display the Sound Card Selection screen. Select “Hi-Fi Cable Input” to output I/Q data from HSDR.

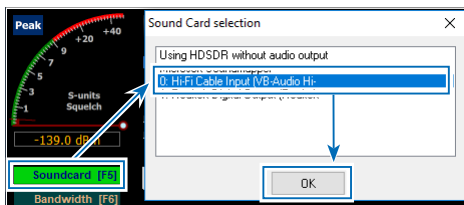

4. Click <Bandwidth> to set **Output Sampling Rate [Hz]** to “192000.”

5. Click <Options> and set **Output Channel Mode for RX** to “IF as I (Left) / Q (Right).”

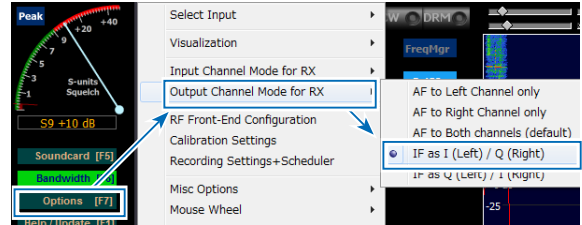

IQ-Gain setting is displayed on the HSDR Main screen.

- ① Normally “0dB” is used but you can adjust the gain level according to your situation. (p. 21)



6. Click <Options> and set the items as described below.

- Click “CAT to HSDR” → “Port” and select the COM port that is set in com0com.
- Click “CAT to HSDR” and select “activated.”

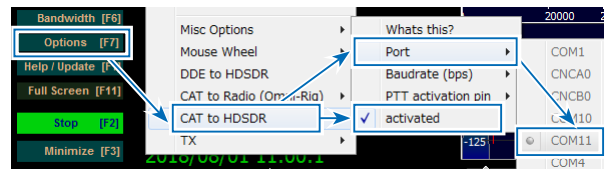

◇ Settings: Checking the CW band on CW Skimmer while communicating in the SSB mode (continued)

**CW Skimmer**

1. To input I/Q data to the CW Skimmer, click <View> → <Settings> → the “Radio” tab, and then set the items as described below.

**Hardware Type:** SoftRock-IF  
**Sampling Rate:** 192 kHz

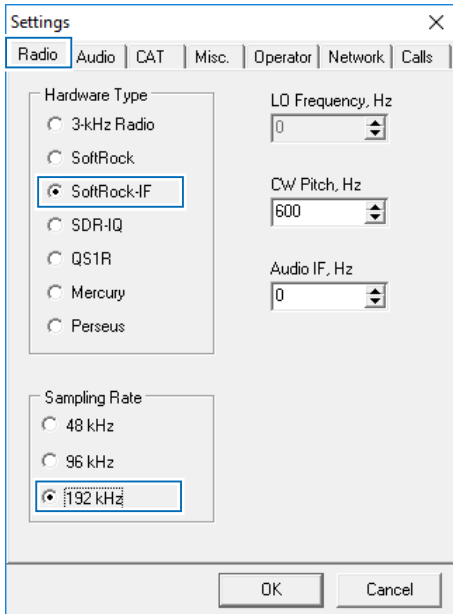

2. To input the I/Q data and output the demodulated audio on the CW Skimmer to the speaker, click the “Audio” tab, and then set the items as described below.

**Signal I/O Device:** Hi-Fi Cable Output  
**Audio I/O Device:** A speaker connected to your PC

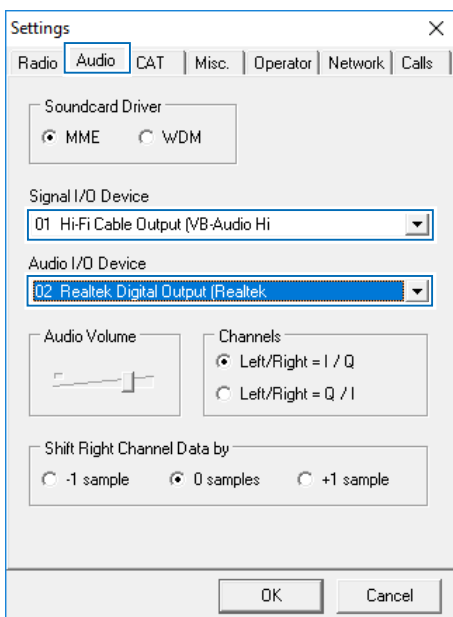

3. To control the frequency synchronization, click the “CAT” tab, and then set the item as described below.

**CAT Interface:** Use Radio 1

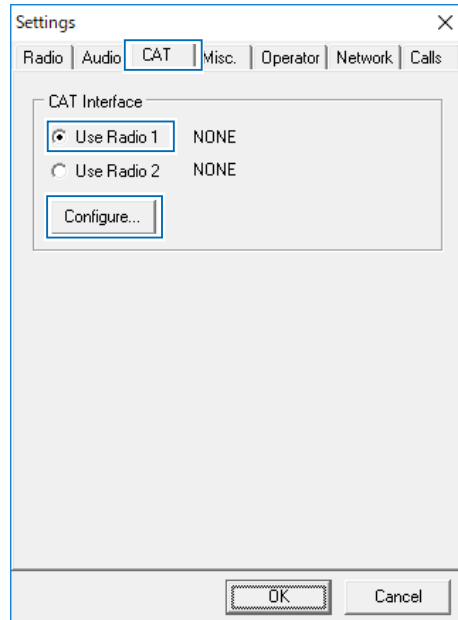

4. Click <Congifure...> to open Omni-Rig Settings screen, and then set the items as described below.

**Rig type:** Kenwood  
**Port:** Select a COM Port that is in com0com and not set in HSDR.  
**Poll int. ms:** 100  
**Timeout. ms:**100

① For other settings, see the screen below.

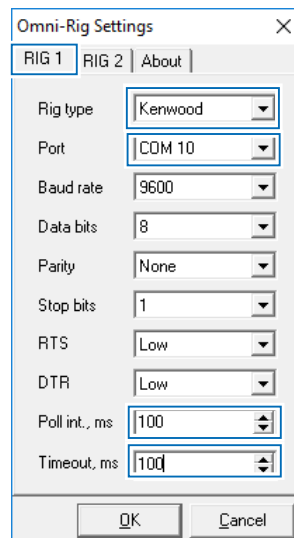

**TIP:** You can check the required settings on the HSDR Main screen.  
 <Options> → <CAT to HSDR> → <What’s this ?>

◇ Action: Checking the CW band on CW Skimmer while communicating in the SSB mode

Click <Start> on the HSDR Main screen, and then click <Start> on the CW Skimmer's tool bar.

- The waveform is displayed on CW Skimmer.
- The IC-7610 SUB band operating frequency, the HSDR LO frequency, the HSDR Tune frequency, and the CW Skimmer frequency are set to the same frequency.
- ① When changing the frequency, all frequencies are synchronized. Clicking on the signal or the call sign on CW Skimmer sets the operating frequency to the IC-7610 SUB band.
- ① Right after the frequencies are changed, the waveform on CW Skimmer may be disturbed. However, after few seconds, the waveform is correctly displayed.

CW Skimmer

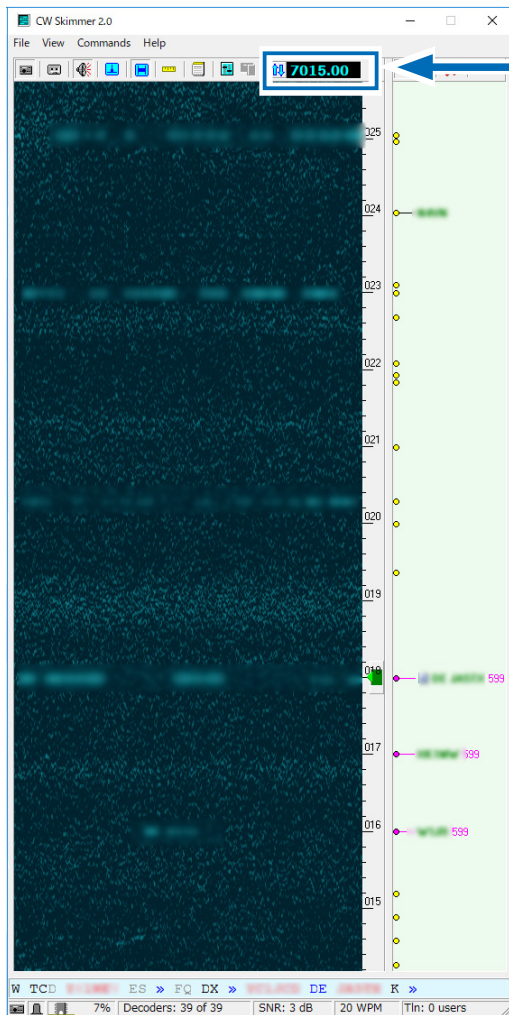

HSDR

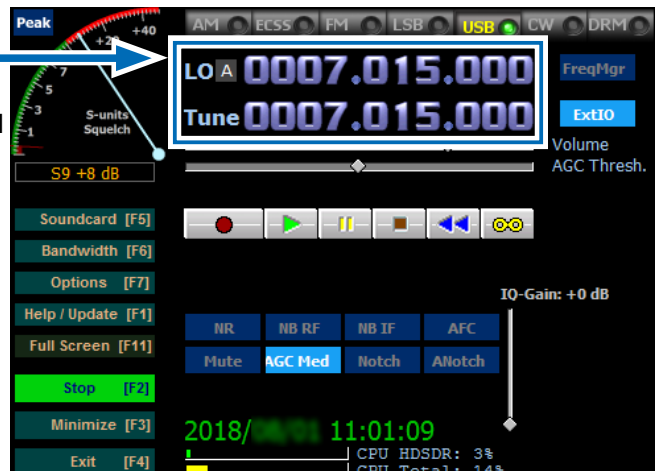

All synchronized

IC-7610

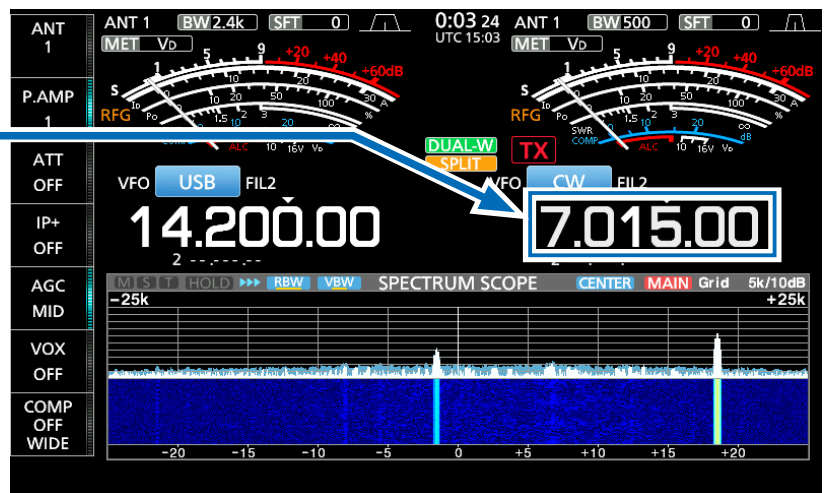

## ◇ Troubleshooting

If the straight line as shown to the right is displayed on CW Skimmer, adjust the IQ-Gain setting on HSDR. The straight line is displayed because of a sharp spike (a DC), if the noise floor is too low.

- ① The IQ-Gain setting is displayed by <Options> and set **Output Channel Mode for RX** to "IF as I (Left) / Q (Right)." (pp. 8, 13, 18, 24)

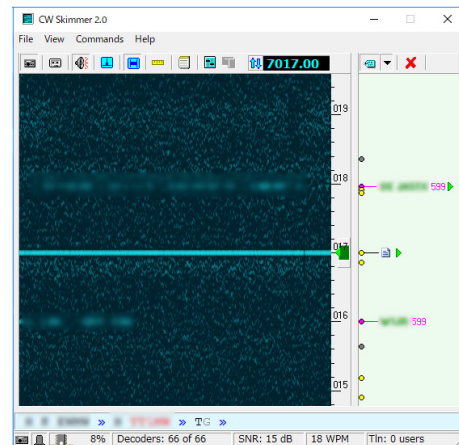

### TIP: When adjusting the IQ-Gain setting

- The IQ-Gain should not be too high. After the straight line is disappeared, do not set the gain higher than that level.
- If the IQ-Gain is too high, CW Skimmer becomes easily saturated when receiving a strong signal. If CW Skimmer is saturated, lower the IQ-Gain or lower the input level on the IC-7610.
  - Turn OFF the Preamplifier.
  - Turn ON the Attenuator function.
  - Lower the RF gain.
  - Turn ON the Digital Selector function.

## D. Using CW Skimmer with HSDR (For a wide\* bandwidth)

### ◇ Operation

\* Approximately 170 kHz

- Select the CW mode on the IC-7610 MAIN band and set the operating frequency of the CW band you want to decode.
  - ① The station information decoded on CW Skimmer through HSDR is input to N1MM Logger+.
- Click the displayed station on N1MM Logger+.
  - The frequency is set to the IC-7610 MAIN band.
- Transmit to the station.

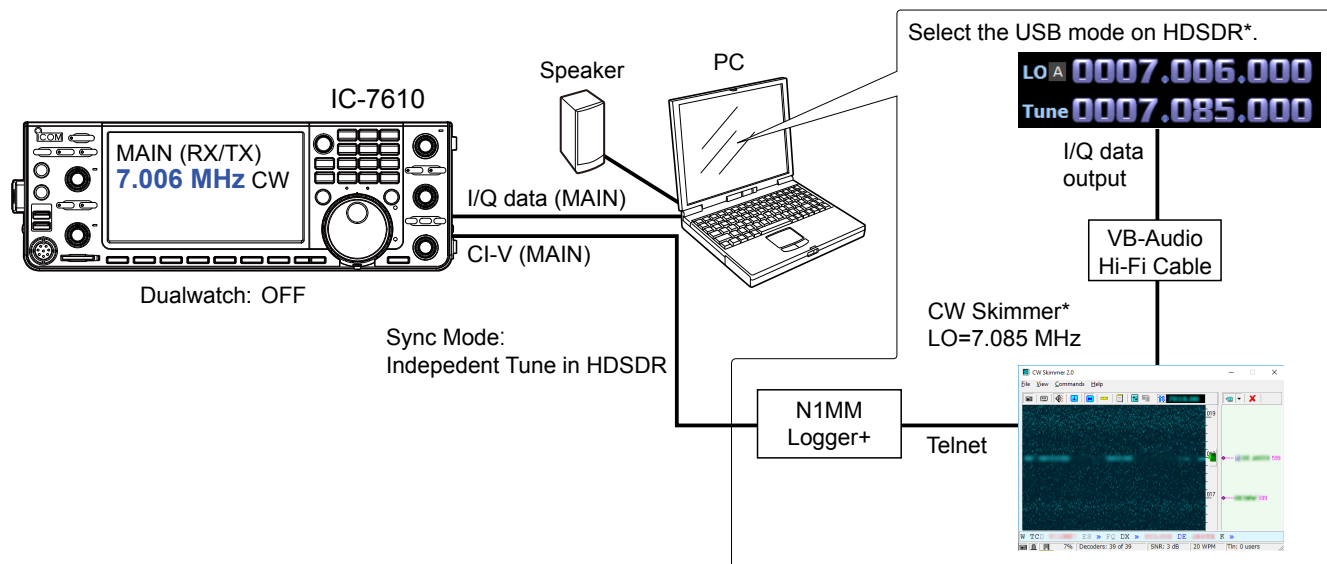

\* Manually set both the HSDR Tune frequency and the CW Skimmer LO frequency to the same frequency.

### ① Information

- You can not hear the demodulated audio from HSDR because HSDR in this case is used for only I/Q data conversion.
- You can hear the demodulated audio of the operating frequency from CW Skimmer, regardless of IC-7610 operating frequency.
- The I/Q data output from HSDR is input to CW Skimmer through VB-Audio Hi-Fi Cable.
- The decoded result is output to N1MM Logger+ through Telnet.
- Connects the USB cable to the PC. N1MM Logger+ remotely controls the IC-7610 by the CI-V commands.

When you want to connect the IC-7610 SUB band to HSDR, turn ON the Dualwatch function and select the SUB band on IC-7610 I/Q Settings screen on HSDR.

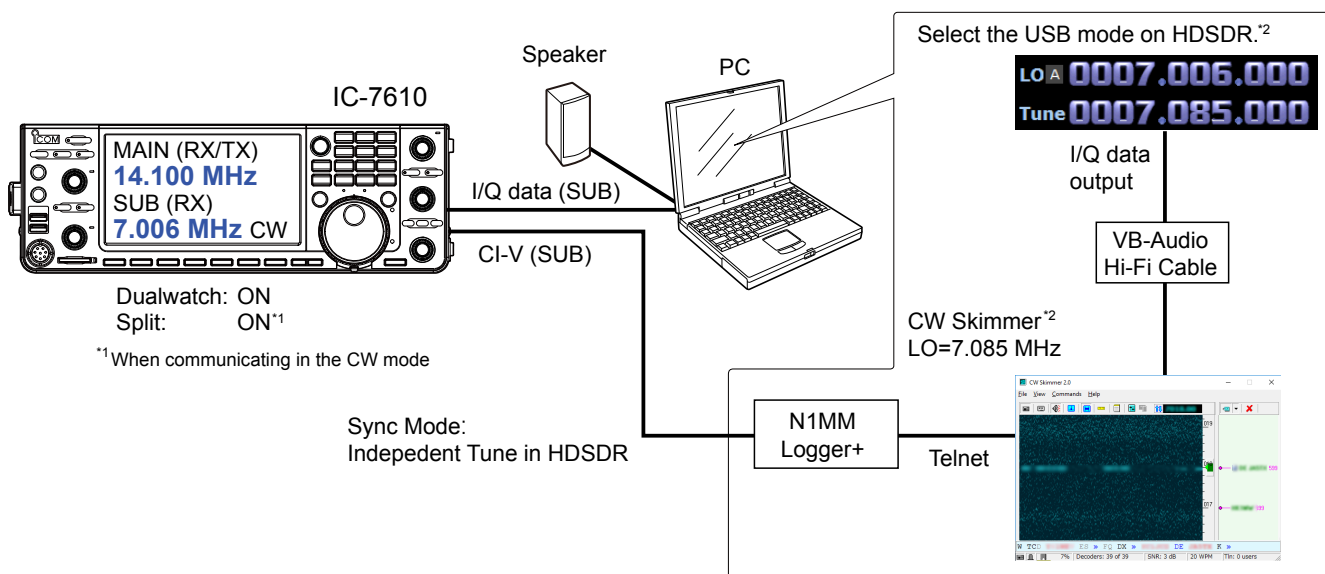

\*2 Manually set both the HSDR Tune frequency and the CW Skimmer LO frequency to the same frequency.

## ◇ Settings

**NOTE:** First, setup VB-Audio Hi-Fi Cable before setting up HSDR. The setup is required only for the first time.

### VB-Audio Hi-Fi Cable

1. From the desktop, right-click your taskbar's Speaker icon and select "Recording device."
2. Click the "Recording" tab.
3. Select "Hi-Fi Cable Output" from the list and click <Properties>.

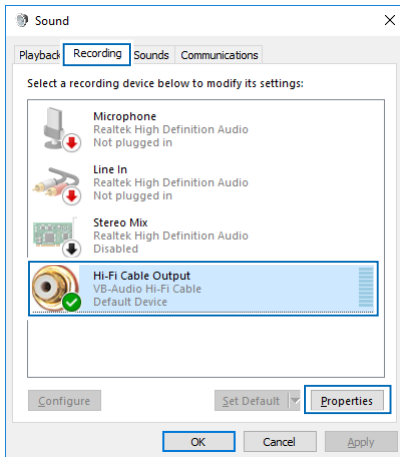

4. Click the "Advanced" tab.

5. Set "Default Format" to "2 channel, 16 bit, 192000 Hz," and then click <OK>.

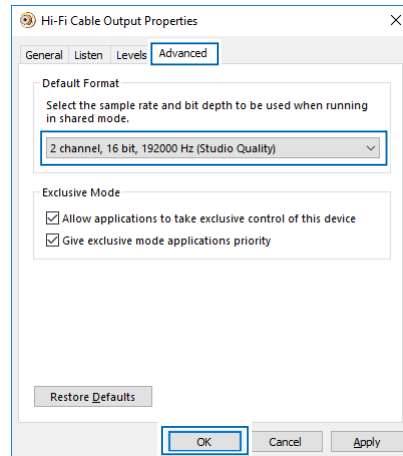

6. Click the "Playback" tab.
7. Select "Hi-Fi Cable Input" from the list and click <Properties>.
8. Click the "Advanced" tab.
9. Set "Default Format" to "16 bit, 192000 Hz," and then click <OK>.

◇ Settings

**HSDR**

1. Set the operating mode to “USB.”
2. Click <Ext IO> to display the IC-7610 I/Q Settings screen. Set the items as described below.  
**MAIN/SUB:** MAIN or SUB  
**Sync Mode:** Independent Tune in HSDR

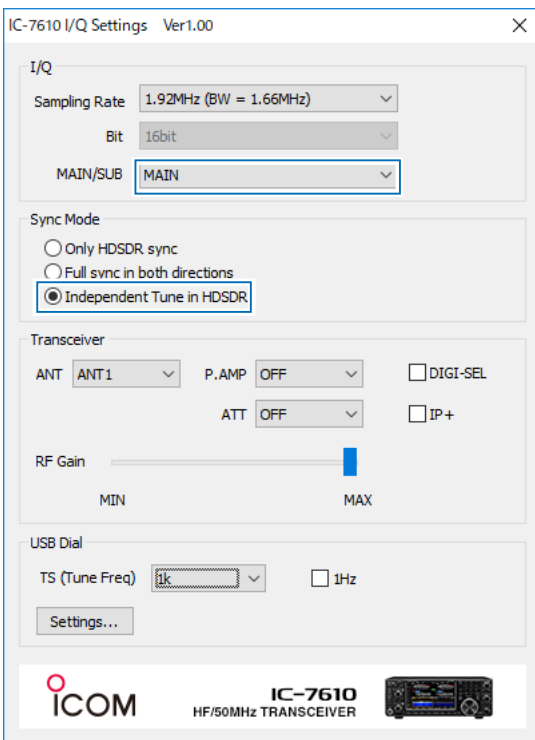

3. Click <Soundcard> to display the Sound Card Selection screen. Select “Hi-Fi Cable Input” to output I/Q data from HSDR.

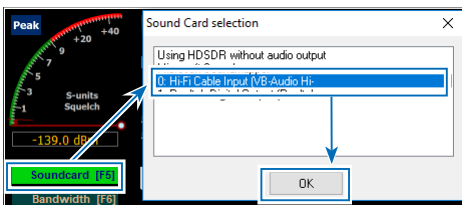

4. Click <Bandwidth> to set **Output Sampling Rate [Hz]** to “192000.”

5. Click <Options> and set **Output Channel Mode for RX** to “IF as I (Left) / Q (Right).”

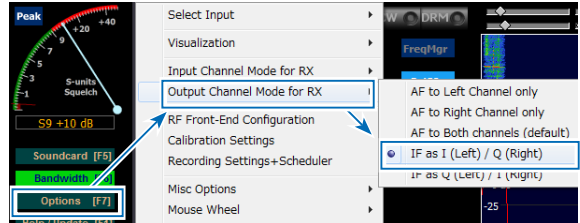

IQ-Gain setting is displayed on the HSDR Main screen.

- ① Normally “0dB” is used but you can adjust the gain level according to your situation. (p. 21)



6. Set the HSDR Tune frequency to the center of the frequency range you want to decode.

- ① For example, if you want to decode the frequency range 7.000 MHz ~ 7.170 MHz, set the center frequency to 7.085 MHz.

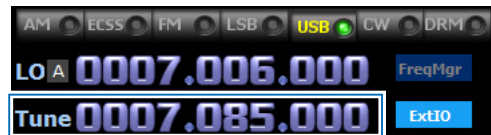



◇ Settings

**CW Skimmer**

1. To input I/Q data to the CW Skimmer, click <View> → <Settings> → the “Radio” tab, and then set the items as described below.

**Hardware Type:** SoftRock  
**Sampling Rate:** 192 kHz  
**LO Frequency, Hz:** The same frequency as the HDSDR Tune frequency.

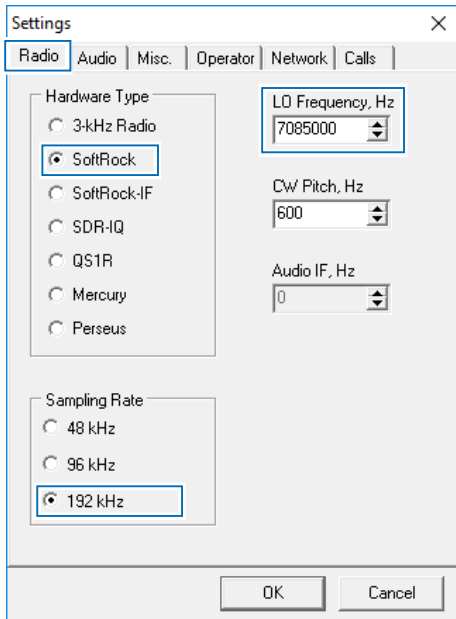

2. To input the I/Q data and output the demodulated audio on the CW Skimmer to the speaker, click the “Audio” tab, and then set the items as described below.

**Signal I/O Device:** Hi-Fi Cable Output  
**Audio I/O Device:** A speaker connected to your PC

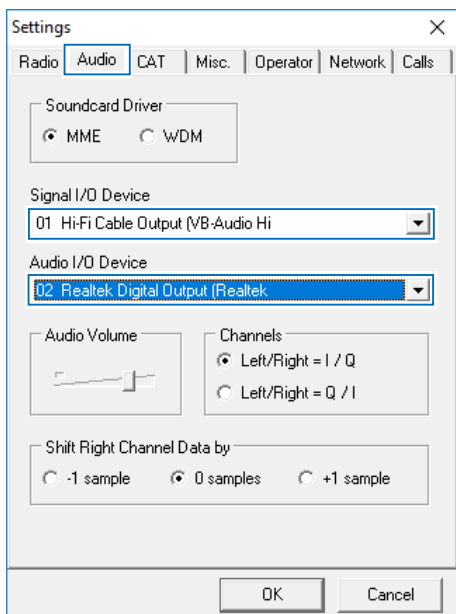

3. To output the decoded result to N1MM Logger+, click the <Network> tab, and then set the items as described below.

**Enable Telnet Server:** Put a check mark.  
**Port:** Default setting (7300) is recommended.

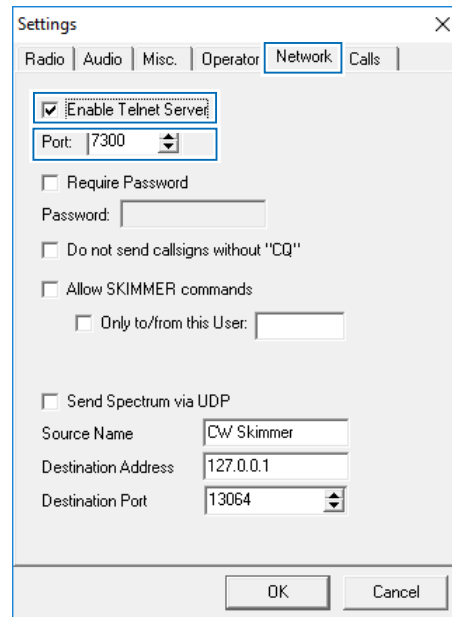

4. Click <OK>.
  - ① If a fire wall setting confirmation screen is displayed, allow access.

◇ Settings

**N1MM Logger+**

1. Click <Config> → <Configure Ports, Mode Control, Audio, Other...> to open the Configurer screen.
2. Click the “Harware” tab, and then set the items as described below.  
**Port:** Select a COM port number used for the IC-7610 CI-V communication  
**Radio:** IC-7610
3. Click <Set> to display the COM port number screen, and then set the items described below.  
**Speed:** CI-V Baud Rate set on the IC-7610  
 ⓘ For other settings, see the screen below.

4. Click <Tools> → <Telnet Window Tools> to open the Telnet screen.
5. Click “Filter” tab and then set the items as described below.  
**Randomize incoming Spot Frequencies:** Remove the check mark.

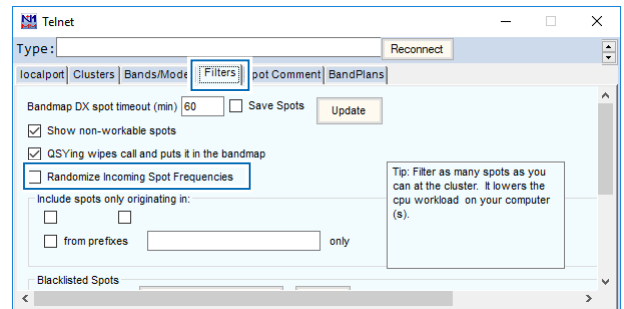
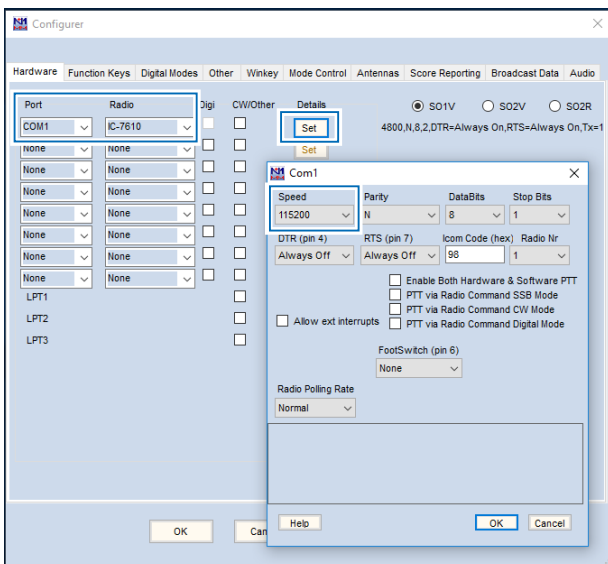

6. Click “Clusters” tab and then set the item as described below.  
**Selected Cluster:** localport
7. Click <Connect to local port>.

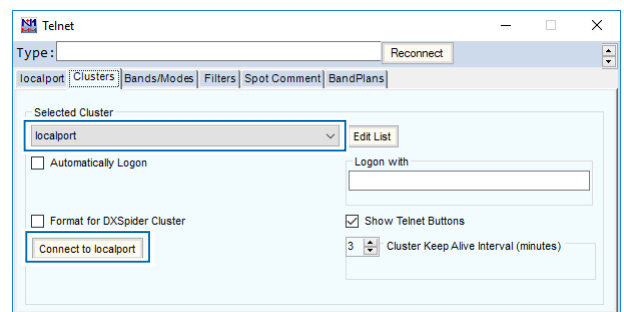

8. Enter your call sign into Type, and then push [Enter] on your PC’s keyboard.

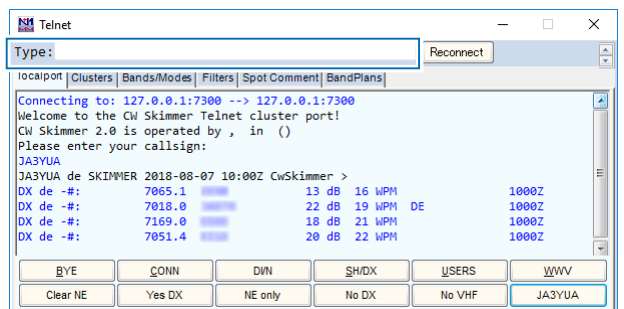

◇ Action

The approximately 170 kHz wide frequency range from the center frequency (the HSDR Tune frequency) is decoded on CW Skimmer, and the decoded result is displayed on N1MM Logger+. Click the displayed station on N1MM Logger+ to set the frequency to the IC-7610.

① Even if you change the IC-7610 operating frequency or the HSDR LO frequency, the HSDR Tune frequency is not changed.

① The CW Skimmer frequencies do not affect the operation.

HSDR

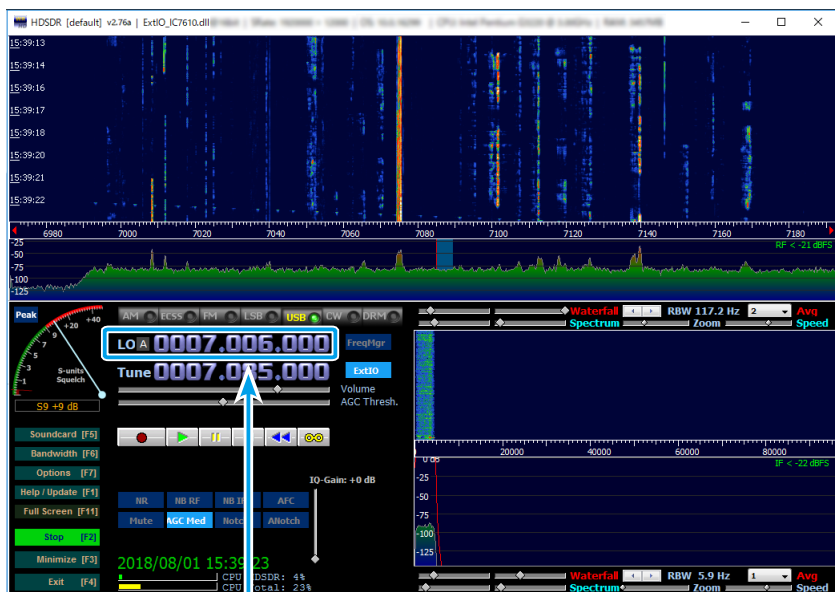

CW Skimmer

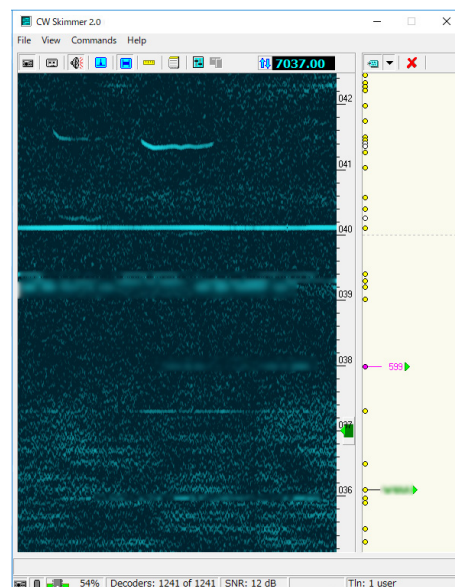

Synchronized

IC-7610

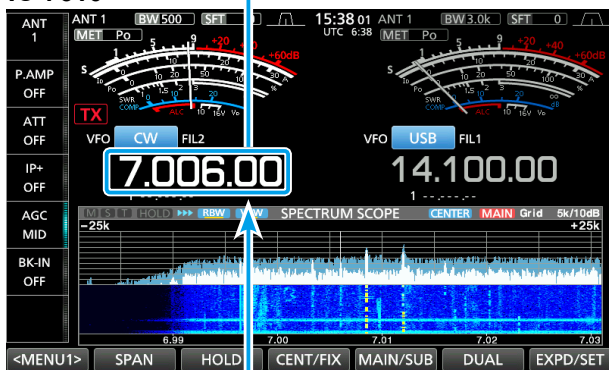

Click the displayed station on N1MM Logger+ to set the frequency to the IC-7610.

N1MM Logger+

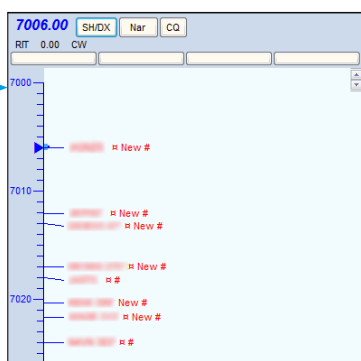
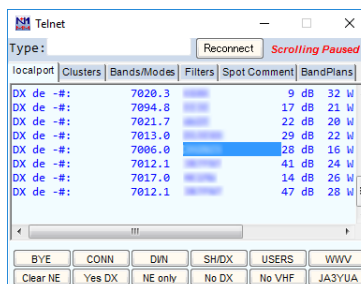
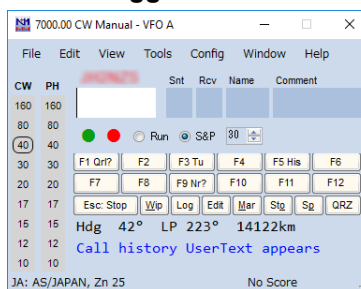

## HSDR setting notes

### ◇ Tune fixed to 'LO <-> Tune Offset'

To eliminate a setting contention, click <Options> → <Misc Options> and remove the check mark from **Tune fixed to 'LO <-> Tune Offset.'**

This setting competes with the setting on the IC-7610 I/Q Setting screen.

- ① If you want to put a check mark in **Tune fixed to 'LO <-> Tune Offset,'** set **Sync Mode** to “Only HSDR sync” on the IC-7610 I/Q Setting screen.

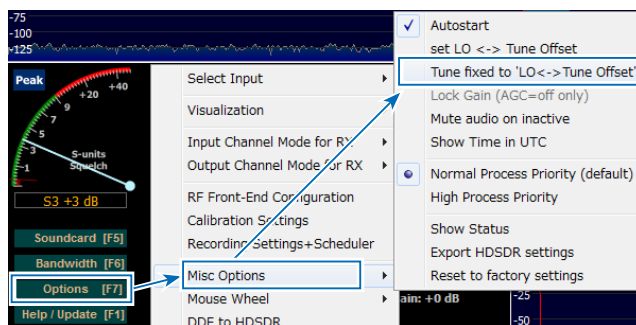

### ◇ The Lock function

The Lock function also competes with the setting on the IC-7610 I/Q Setting screen. The HSDR Lock function is not usable.

- ① When you click on “LO” or “Tune” next to the frequency, “Locked” is displayed. When the HSDR Lock function correctly works, the frequency cannot be changed.
- ① If you want to use this setting, set **Sync Mode** to “Only HSDR sync” on the IC-7610 I/Q Setting screen.

# IC-7610 I/Q Settings screen

This screen is displayed by clicking “Ext IO” on the HSDR Main screen.

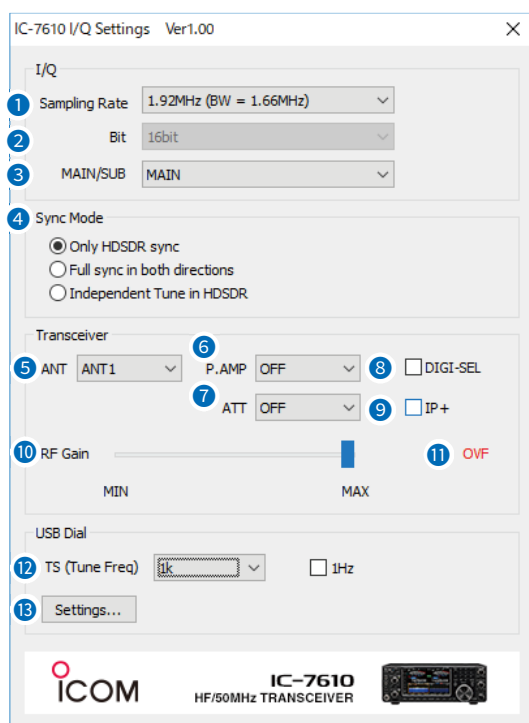

## 1 Sampling Rate

(Default: 1.92 MHz (BW = 1.66 MHz))

Select the sampling rate of the signal that is input to a HSDR.

- ① The frequency range changes, depending on the set sampling rate.
- ① If the audio is interrupted, select a lower sampling rate.

## 2 Bit

(Default: 16 bit)

Select the bit depth of the signal that is input to the HSDR.

- ① When **Sampling Rate** (1) is set to “1.92 MHz (BW = 1.66 MHz),” **Bit** is set to “16bit.”

## 3 MAIN/SUB

(Default: MAIN)

Select the IC-7610 MAIN band or SUB band to input the I/Q signal to HSDR.

- ① When selecting “SUB,” the Dualwatch function on the IC-7610 is automatically turned ON.

## 4 Sync Mode

(Default: Only HSDR sync)

Select whether or not the HSDR Tune frequency is synchronized with the IC-7610.

- Only HSDR sync:
  - Select this option when “A. Using the IC-7610 as an SDR.” When changing the IC-7610 operating frequency or the HSDR LO frequency, the HSDR Tune frequency is changed based on the LO frequency.
- Full sync in both directions:
  - Select this option when “C. Using CW Skimmer with HSDR (For a narrow 24 kHz bandwidth).” The IC-7610 operating frequency, the HSDR LO frequency, the HSDR Tune frequency, and the CW Skimmer frequency are synchronized.

- Independent Tune in HSDR:
  - Select this option when “B. Using HSDR as a 3rd receiver” or “D. Using CW Skimmer with HSDR (For a wide bandwidth).” Even if you change the IC-7610 operating frequency or the HSDR LO frequency, the HSDR Tune frequency is not changed.

## 5 ANT

Select antenna connector ANT 1, ANT 2, ANT 1/R, or ANT 2/R.

- ① If **RX-ANT Connectors** on the IC-7610 is set to “RX-I/O,” you cannot select “ANT 1/R” or “ANT 2/R.”

## 6 P.AMP

Turn the Preamplifier function ON or OFF.

## 7 ATT

Select the Attenuator setting.

## 8 DIGI-SEL

Turn the DIGI-SEL function ON or OFF.

## 9 IP+

Turn the IP Plus function ON or OFF.

## 10 RF Gain

Adjust the RF gain (sensitivity).

## 11 OVF

Displayed when receiving an excessively strong signal. If it is displayed, decrease the input level from the IC-7610.

## 12 TS (Tune Freq), 1 Hz

(Default: 1k (except for the FM mode), 25k (FM mode))

Select the tuning steps when you set the Tune frequency using the RC-28 REMOTE ENCODER (When the TS function on the RC-28 is ON).

### ① Information

- When the TS function is OFF, the tuning step is set to 10 Hz.
- When putting a check mark in **1 Hz**, the tuning step is changed to 1 Hz.
- When rotating RC-28’s [Main dial] to set the LO frequency, the tuning step depends on **Sampling Rate** (1).

### Tuning steps when you set the LO frequency using the RC-28

Sampling Rate	TS is ON	TS is OFF
1.92 MHz	1 MHz	100 kHz
960 kHz	100 kHz	10 kHz
480 kHz		
240 kHz		
120 kHz		
60 kHz	10 kHz	1 kHz
30 kHz		

## 13 <Settings...>

Click to display the USB Dial Settings screen. (p. 30)

## USB Dial Settings screen

This screen is displayed by clicking <Settings...> on the IC-7610 I/Q Settings screen.

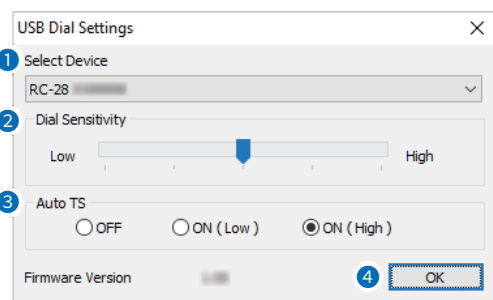

### 1 Select Device

Select the RC-28 to operate the IC-7610 through the HSDR software.

- ① The RC-28 whose [LINK] indicator lights green is automatically selected.

### 2 Dial Sensitivity

(Default: 3)

Set the dial sensitivity to one of 5 levels.

When a low level is set, the dial speed is reduced for finer tuning control.

When a high level is set, the dial speed increases.

### 3 Auto TS

(Default: ON (High))

When you rapidly rotate the dial, the tuning speed accelerates, depending on this setting.

- OFF: Normal tuning steps, even during a rapid rotation.
- ON (Low): The tuning speed is approximately 2 times faster.
- ON (High): When the tuning step is set to 1 kHz or smaller steps, the tuning speed is approximately 5 times faster. When the tuning step is set to larger than 1 kHz, the tuning speed is approximately 2 times faster.

### 4 <OK>

Click to save the settings and close the screen.

## Using the RC-28

If you connect the optional RC-28 REMOTE ENCODER to the PC, you can use HSDR and feel like you are operating the actual IC-7610's main dial.

1. Connect the RC-28 to a PC that has HSDR installed.

**NOTE: DO NOT** connect the RC-28 to the PC with other than the supplied USB cable, or through any USB hub. Otherwise the RC-28 may not work properly.

- ① When you connect the RC-28 to the PC for the first time, wait until "Device driver software installed successfully." is displayed.

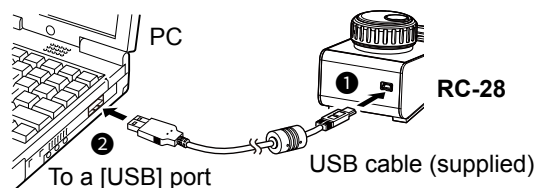

2. Start up HSDR.

- The [LINK] indicator on the RC-28 lights green.

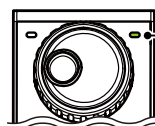

[LINK] indicator

- Now you can control the assigned functions of HSDR using the RC-28.

**TIP:** If the [LINK] indicator does not light, confirm **Select Device** on the USB Dial Settings screen is set to the RC-28's serial number.  
(Example: RC-28 02XXXXX)

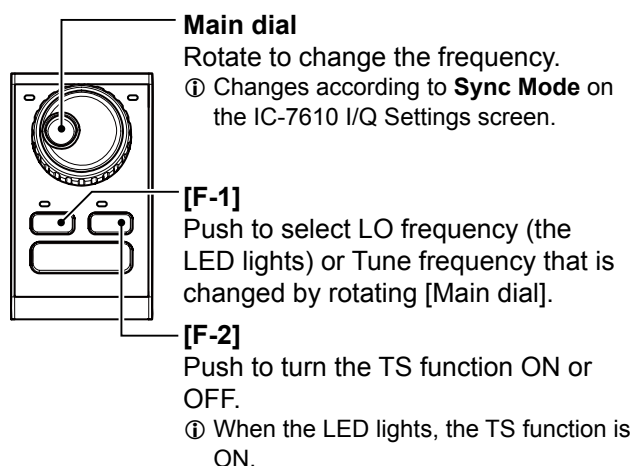

- ① [TRANSMIT] is disabled during HSDR operation.

# Setting Guide for using HSDR, and the difference between version.2.80 and 2.76a

This document describes how to use HSDR version 2.80 with the “IC-7610 USB I/Q Package for HSDR,” and explains the difference between HSDR version 2.76a and HSDR version 2.80.

## ◇ How to open “IC-7610 I/Q Settings” in HSDR

There are different setting displays, as follows.

- When using version 2.80

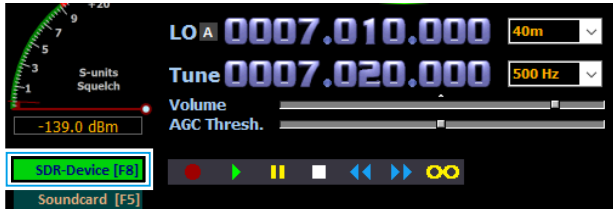

- When using version 2.76a



## ◇ Sync Mode settings

Click to select “Only HSDR sync” (default) in **Sync Mode** before using CW Skimmer or using HSDR version 2.80 as a 3rd receiver.

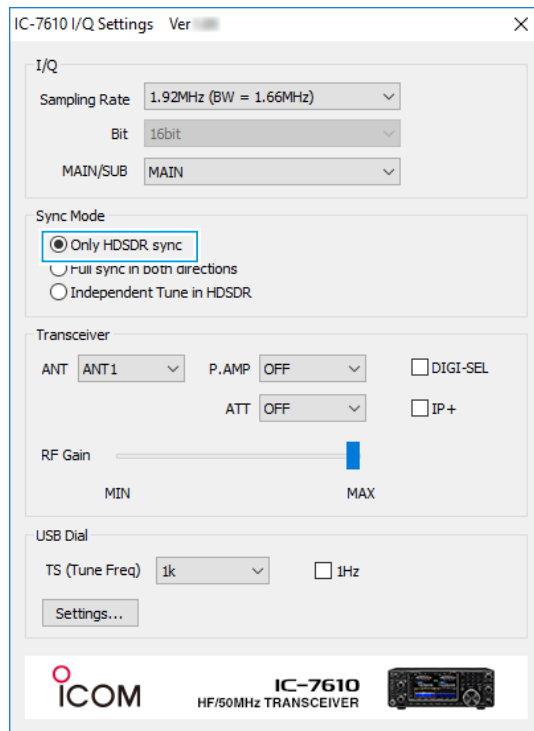

## A. Settings: Using the IC-7610 with HSDR

Click to select “Only HSDR sync” on **Sync Mode** in the IC-7610 I/Q setting screen.

1. Click <Options>, and then click **Misc Options**.  
Click “Keep Tune when LO is changed” to remove the check mark.

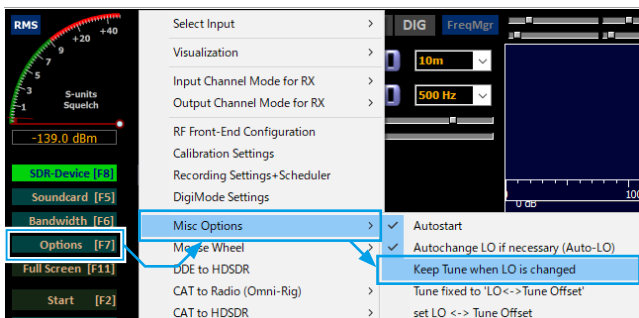

2. Click <Options>, and then click **Misc Options**.  
Click “Tune fixed to ‘LO<->Tune Offset’” to remove the check mark.

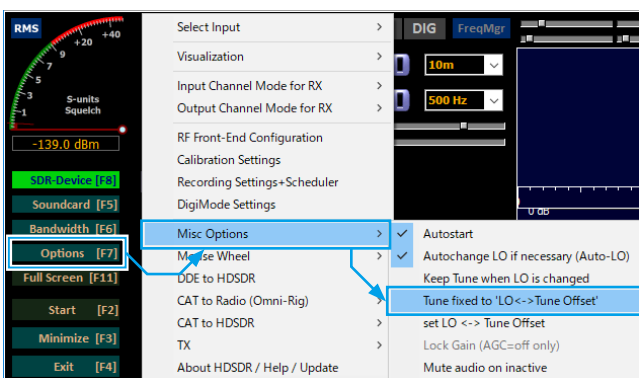

## B. Settings: Using CW Skimmer with HSDR version 2.80 (for a narrow 24 kHz bandwidth)

Set **Sync Mode** to “Only HSDR sync” in the IC-7610 I/Q setting screen.

1. Click <Options>, and then click **Misc Options**. Click “set LO <->Tune Offset” to change it to “0.”

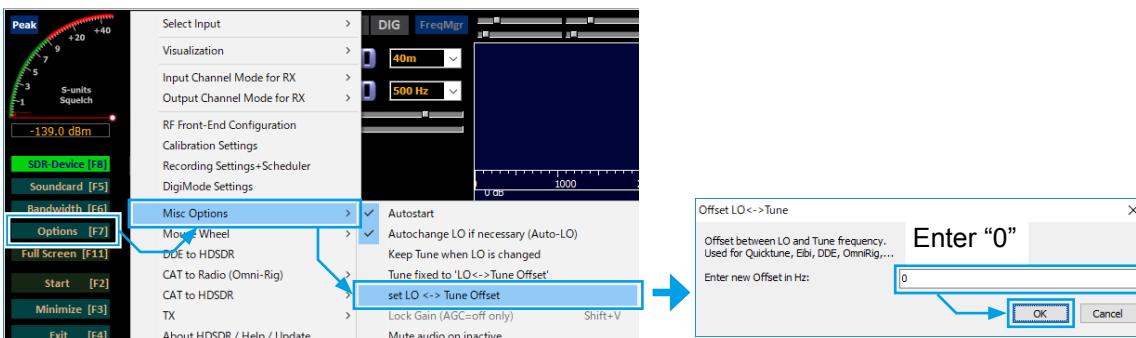

2. Click <Options>, and then click **Misc Options**. Click “Tune fixed to ‘LO <->Tune Offset’” to add a check mark.  
① Although the same items are described on page 28 of “IC-7610 HSDR Operating Guide,” when using HSDR version 2.80, configure as described below.

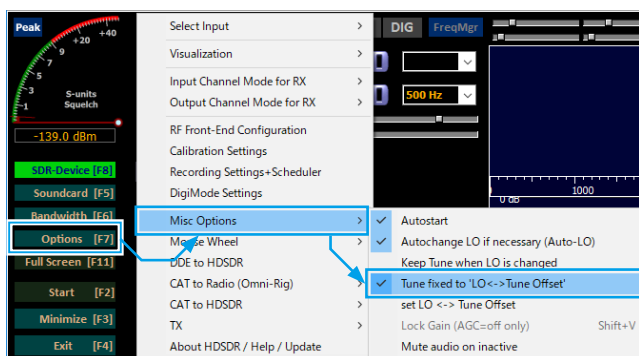



### C. Settings: Using HSDR version 2.80 as a 3rd receiver, and using CW Skimmer (for a wide bandwidth)

Click to set **Sync Mode** to “Only HSDR sync” in the IC-7610 I/Q setting screen.

Click <Options>, and then click **Misc Options**. Click “Keep Tune when LO is changed” to add a check mark.

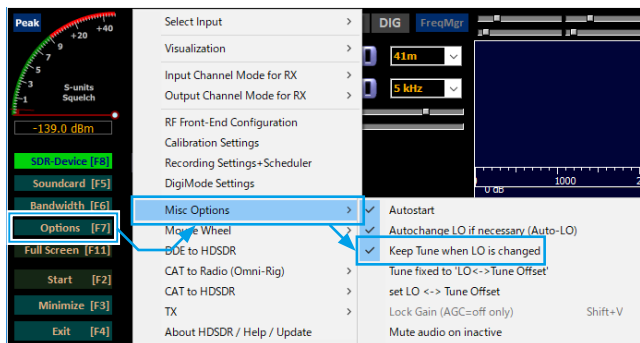

### ◆ Settings: Receiving mode

The Key name is different for the Digital mode.

Click “DIG” or “DRM,” depending on the HSDR version, to select the Digital mode when you are using an SDR receiver, or HSDR as a 3rd receiver.

- When using version 2.80 : Select “DIG”



- When using version 2.76a : Select “DRM”



You can configure the sound card’s Output and Mode when “DIG” is selected.

Click <Options>, and then click <DigiMode Settings>.

